

**KFORCE**

**USER MANUAL**



**WE**

# Index

<b>1. Important information</b>	<b>4</b>
<b>2. Introduction and required tools</b>	<b>9</b>
<b>3. Pairing</b>	<b>11</b>
Powering	11
Connecting Shifters	13
Connecting Shifters Disc Brake	15
<b>4. Drivetrain Parts</b>	<b>18</b>
Part Names	18
Using the Wiring tool	19
How to Wire	20
Lever Installation	21
Brake Cable Installation	22
Reach adjustments	23
Front Derailleur Installation	24
Rear Derailleur Installation	26
Battery Installation	27
Chain Installation	28
<b>5. How to operate</b>	<b>32</b>
Gear position control	32
<b>6. Usage and adjustments</b>	<b>34</b>
Rear Derailleur Adjustment	34
Front Derailleur Adjustment	36
Limit Screw Adjustment	39
B-tension Screw Adjustment	40
<b>7. Battery</b>	<b>42</b>
Names of parts	42
Battery Diagnostic	43
How to Charge	44
<b>8. Disc Brake Installation</b>	<b>50</b>
<b>9. Diagnostic</b>	<b>65</b>

**Important Information**



Congratulations on your Full Speed Ahead product. Please read these instructions and follow them for correct use. Failure to follow the warnings and instructions could result in damage to product not covered under warranty, damage to bicycle; or cause an accident resulting in injury or death. Since specific tools and experience are necessary for proper installation, it is recommended that the product be installed by a qualified bicycle technician. FSA assumes no responsibility for damages or injury related to improperly installed components.

## Important Information



Risk of explosion if battery is replaced by an incorrect type. Dispose of used batteries according to the instructions.

If your device endures electrostatic discharge, it may automatically reboot and disconnect current wireless transmission. You will need to manually reset the wireless connection when this happens.

Use your device in temperature between  $-5^{\circ}\text{C}$  ~  $40^{\circ}\text{C}$ . Exposing your device to extremely low or high temperatures may result in damage, malfunction, or even explosion.

## FCC Compliance Statement

This device complies with part 15 of the FCC Rules. Operation is subject to the following two conditions: (1) This device may not cause harmful interference, and (2) this device must accept any interference received, including interference that may cause undesired operation.

Changes or modifications not expressly approved by the party responsible for compliance could void the user's authority to operate the equipment.

This equipment has been tested and found to comply with the limits for a Class B digital device, pursuant to part 15 of the FCC Rules. These limits are designed to provide reasonable protection against harmful interference in a residential installation. This equipment generates, uses and can radiate radio frequency energy and, if not installed and used in accordance with the instructions, may cause harmful interference to radio communications. However, there is no guarantee that interference will not occur in a particular installation. If this equipment does cause harmful interference to radio or television reception, which can be determined by turning the equipment off and on, the user is encouraged to try to correct the interference by one or more of the following measures:

- Reorient or relocate the receiving antenna.
- Increase the separation between the equipment and receiver.
- Connect the equipment into an outlet on a circuit different from that to which the receiver is connected.
- Consult the dealer or an experienced radio/TV technician for help.

## FCC RF Exposure Information

This device is designed and manufactured not to exceed the emission limits for exposure to radio frequency (RF) energy set by the Federal Communications Commission for an uncontrolled environment.

### ISED Compliance Statement

This device complies with Industry Canada's licence-exempt RSSs. Operation is subject to the following two conditions:

- (1) This device may not cause interference; and
- (2) This device must accept any interference, including interference that may cause undesired operation of the device.

Le présent appareil est conforme aux CNR d'Industrie Canada applicables aux appareils radio exempts de licence.

L'exploitation est autorisée aux deux conditions suivantes:

- (1) l'appareil ne doit pas produire de brouillage, et
- (2) l'utilisateur de l'appareil doit accepter tout brouillage radioélectrique subi, même si le brouillage est susceptible d'en compromettre le fonctionnement."

CAN ICES-3(B)/NMB-3(B)

### **ISED RF Exposure Information**

This equipment complies with Innovation, Science and Economic Development Canada RSS-102 RF exposure limits set forth for an uncontrolled environment.

### **ISED Informations sur l'exposition RF**

Cet équipement est conforme aux limites d'exposition RF RSS-102 d'Innovation, Sciences et Développement économique Canada établies pour un environnement non contrôlé.

## **CE Compliance Statement**

### **Maximum radio-frequency power transmitted in the frequency bands:**

Model: FD-ED-8400

Bluetooth LE, 2400MHz~2483.5MHz: -5.8 dBm (e.i.r.p.)

ANT+, 2402MHz~2480MHz: -4.8 dBm (e.i.r.p.)

Model: SF-ED-8400

Bluetooth LE, 2400MHz~2483.5MHz: -4.1 dBm (e.i.r.p.)

ANT+, 2402MHz~2480MHz: -5.5 dBm (e.i.r.p.)

### **CE RF Exposure Information**

This device meets the EU requirements and the International Commission on Non-Ionizing Radiation Protection (ICNIRP) on the limitation of exposure of the general public to electromagnetic fields by way of health protection.



### **Waste Electrical and Electronic Equipment (WEEE)**

This symbol means that according to local laws and regulations your product and/or its battery shall be disposed of separately from household waste. When this product reaches its end of life, take it to a collection point designated by local authorities. Proper recycling of your product will protect human health and the environment.

Hereby, FSA srl declares that the radio equipment type [FD-ED-8400 and SF-ED-8400] is in compliance with Directive 2014/53/EU.

The full text of the EU declaration of conformity is available at the following internet address:

<http://www.fullspeedahead.com/en/support/library/documentation>

### **NCC 警語**

本電池如果更換不正確會有爆炸的危險，請依製造商說明書處理用過之電池

### **廢電池請回收**

經型式認證合格之低功率射頻電機，非經許可，公司、商號或使用者均不得擅自變更頻率、加大功率或變更原設計之特性及功能。低功率射頻電機之使用不得影響飛航安全及干擾合法通信；經發現有干擾現象時，應立即停用，並改善至無干擾時方得繼續使用。

前項合法通信，指依電信法規定作業之無線電通信。低功率射頻電機須忍受合法通信或工業、科學及醫療用電波輻射性電機設備之干擾。

# Battery Warning

## Battery

1. Be sure to use only with an FSA charger and follow charging instructions.
2. Do not crush and/or do not puncture the battery.
3. If the battery pack is stored for a long time, the battery pack's storage should be 7.8V~8.0V.

## 4. Charging

### Charging Current

The charging current should be less than the maximum charge current specified in the Product Specification. Charging with a higher current than the recommended value may cause damage to cell/battery pack's electrical, mechanical, and safety performance and could lead to heat generation or leakage.

### Charging Temperature

The cell should be charged within a 0°C~45°C (32°-113°F) range in the Product Specification.

### Prohibition of Reverse Charging

Reverse charging is prohibited. The cell/battery pack should be connected correctly. The polarity has to be confirmed before wiring. In case the cell/battery pack is connected improperly, the cell/battery pack cannot be charged. Likewise, reverse charging may cause damage to the cell/battery pack which may lead to degradation of the cell/battery pack performance, affect the cell/battery pack safety and could cause heat generation or leakage.

## 5. Discharging

### Discharging Current

The cell should be discharged at less than the maximum discharge current specified in the Product Specification. A high discharging current may reduce the discharging capacity significantly or cause over-heating.

### Discharging Temperature

The cell should be discharged within a -20°C~60°C (-4°-140°F) range specified in the Product Specification.

### Over-Discharging

It should be noted that the cell/battery pack would be in an over-discharged state by its self-discharge characteristics if the cell/battery pack has not been used for long time. In order to prevent over-discharging, the (individual) cell should be charged periodically to maintain between 7.8V and 8.0V. Over-discharging may cause loss of cell/battery pack performance, characteristics, or battery functions.

## 6. Storage

The cell/battery pack should be stored within a -10°C~45°C (14°-113°F) range.

## 7. Long Time Storage

If the battery pack is stored for a long time, the battery pack's storage should be 7.8V~8.0V.

Instructions for "long term storage":

- a. Long-term storage can accelerate battery self-discharge and lead to the deactivation of the batteries. To minimize the deactivation, store battery packs in a temperature range of -10°C~45°C (14°-113°F).
- b. When charging for the first time after long-term storage, deactivation of the packs may have led to decreased capacity. To recover the packs to original performance, repeat several cycles of fully charging and discharging.
- c. When storing the pack for more than 6 months, please charge at least once every 6 months to prevent leakage and deterioration in performance due to self-discharging.

## 8. Others

Do not drop, hit or bend the battery body.

### **Battery electrolyte is harmful**

The battery should not have any electrolyte liquid visibly flowing. In case electrolyte comes into contact with the skin or eyes, flush/wash the electrolyte immediately with fresh water and immediately seek medical attention.

### **Prohibition of dumping of cells into fire**

Never incinerate nor dispose of the cells in fire. This may cause a dangerous explosion and is prohibited.

### **Prohibition of cells immersion into liquid such as water**

The cells should never be soaked with liquids such as fresh water, seawater, or drinks such as soft drinks, juices, coffee, etc.

### **Battery cells replacement**

The battery replacement shall be done only by either the battery cell supplier or device supplier and never be done by the user.

### **Prohibition of use of damaged cells**

The cells might become damaged during shipping by shock. If any abnormal features of the cells are found - such as damage to the plastic envelope of the cell, deformation of the cell package, smelling of electrolyte, electrolyte leakage or other abnormal appearance, the cells should not be used.

The cells with a smell of the electrolyte or a leakage shall be placed away from fire to avoid explosion.

# Introduction and required tools





# Introduction





















Congratulations on your Full Speed Ahead product. Please read these instructions and follow them for correct use. Failure to follow the warnings and instructions could result in damage to product not covered under warranty, damage to bicycle; or cause an accident resulting in injury or death. Since specific tools and experience are necessary for proper installation, it is recommended that the product be installed by a qualified bicycle technician. FSA assumes no responsibility for damages or injury related to improperly installed components.

## Required Tools and supplies

**CAUTION**

**FSA recommends installation of WE Drivetrain to be performed by a highly experienced bicycle mechanic.**

The following tools and supplies are needed for correct installation of FSA WE Drivetrain. See tool list below:

 1.5mm hexagon wrench	 2mm hexagon wrench	 2.5mm hexagon wrench
 4mm hexagon wrench	 5mm hexagon wrench	 T10 torx wrench
 T25 torx wrench	 8mm open end wrench	 Torque wrench (2-14 Nm range)
 Phillips screwdriver (PH2)	 Slotted screwdriver	 FSA cable guide tool
 Light grease	 Chain rivet tool (11sp compatible)	 Small pick
 Needle nose pliers	 Brake fluid	 Bleed block
 Hydraulic hose cutting tool	 Hydraulic hose barb insertion tool	 Isopropyl or Denatured Alcohol
 Clean, Lint-Free Rags	 Safety Glasses and Nitrile Gloves	 Shift cable for hose routing

**Pairing**



# POWERING

## Power ON

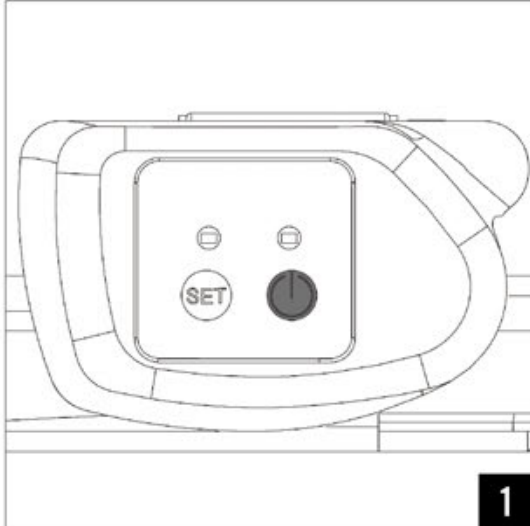

Push and hold the power button.

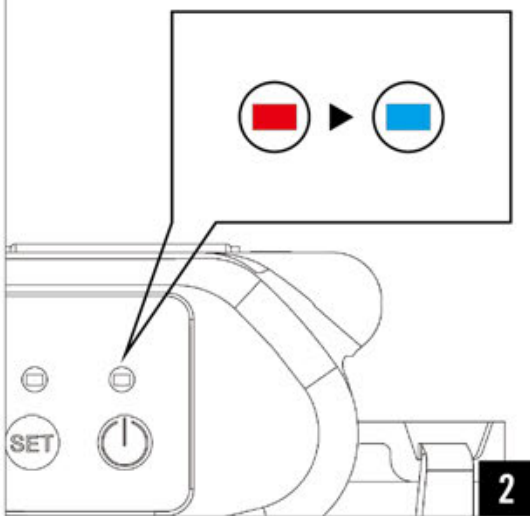

The LED lights will blink red then blue.  
When the LED lights flash blue, WE is on.

### TIPS

Release the power button. Push each shift button once to activate them.

# POWERING

## Power OFF

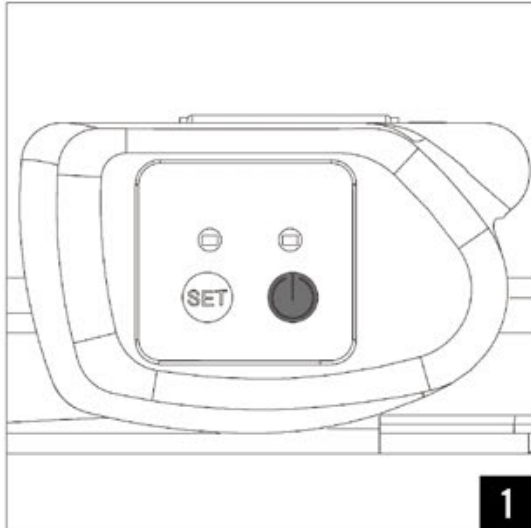

Push and hold the power button.

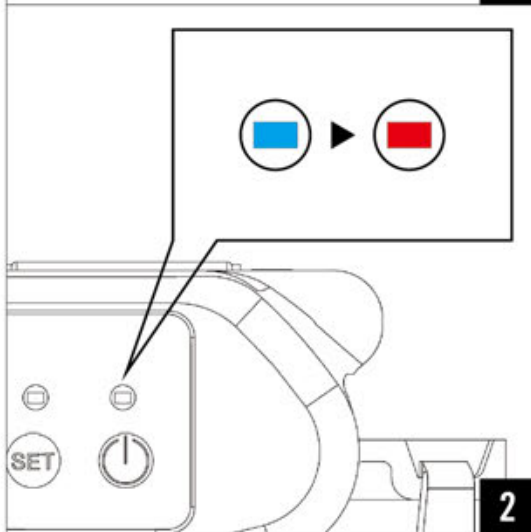



The LED lights will blink blue then red.  
When the LED lights flash red, WE is off.

### TIPS

WE will also go in to Stand-By mode, and turn off automatically after a period of inactivity. Those intervals are customizable in the WE Dashboard Software.

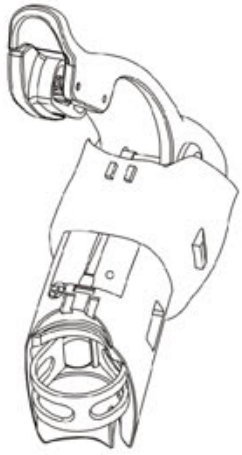
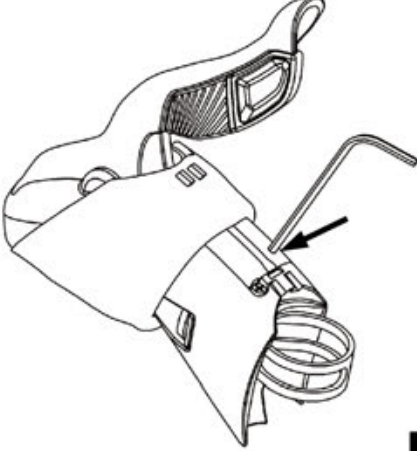
# Connecting shifters

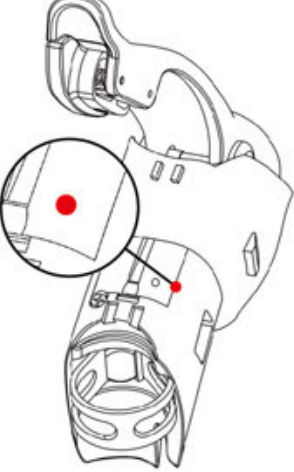
 <p>1</p>	<p>Roll the shifter hood forward to expose the transmitter cover.</p>	
 <p>2</p>	<p>Use the 2mm hex key to depress the pairing button through the port on the underside of the shifter. At the same time press one of the shifter buttons.</p>	
 <p>3</p>	<p>The Pairing LED indicator light will turn solid red.</p>	

## TIPS

If you have pressed the shifting paddle too recently before the pairing button it will not enter pairing mode. You need at least 30s until you can enter pairing mode.

Continued on the next page 

# Connecting shifters

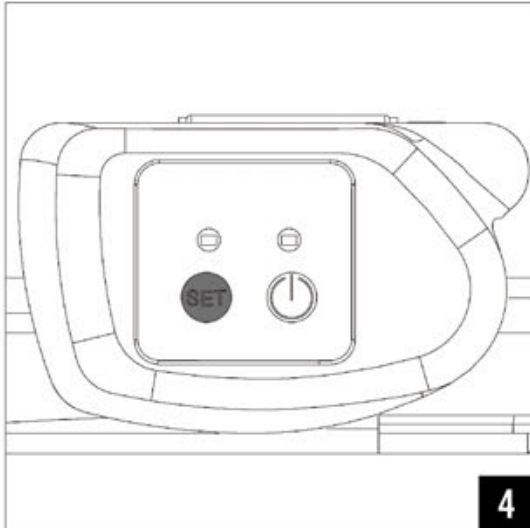

After powering on, press and hold the set button until both LEDs flash green.

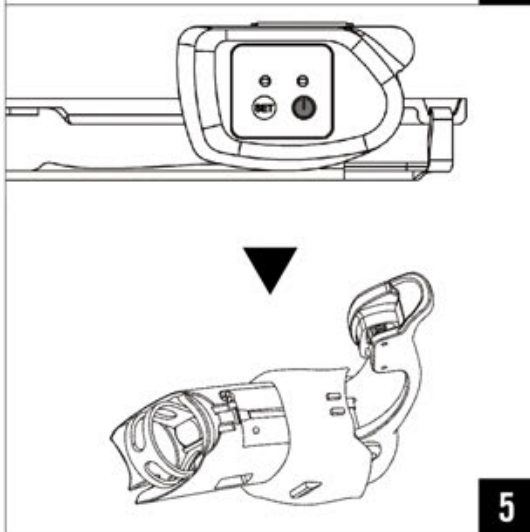





Press and hold the power button until the LED turns solid Blue (about 6s). Once the blue light turns off on the front derailleur and the pairing light on the shifter flashes and turns off, pairing mode is complete.

## TIPS

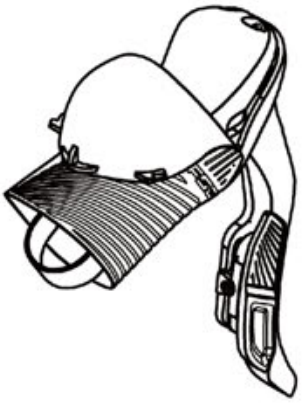
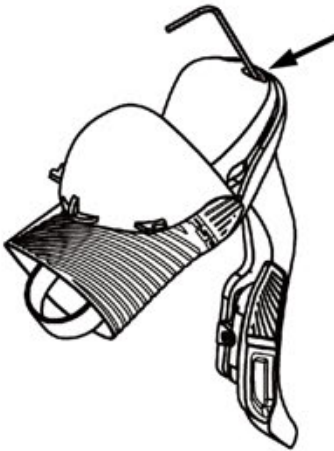
Repeat the above process for the other shifter.

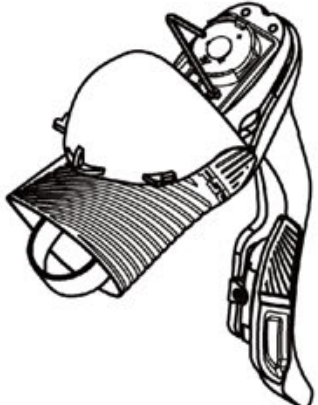
# Connecting Shifters Disc Brake

 <p><b>1</b></p>	<p>Roll the shifter hood backward to expose the transmitter cover.</p>	
 <p><b>2</b></p>	<p>Use the 1.5mm hex key to remove the transmitter cover.</p>	
 <p><b>3</b></p>	<p>Use the 1.5mm hex key to depress the pairing button through the port on the underside of the shifter.</p> <p>At the same time press one of the shifter buttons.</p>	

## TIPS

If you have pressed the shifting paddle too recently before the pairing button it will not enter pairing mode. You need at least 30s until you can enter pairing mode.

Continued on the next page 

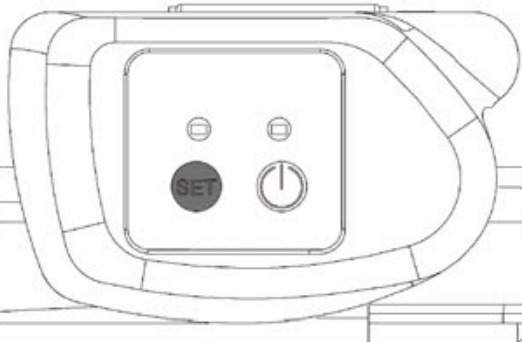
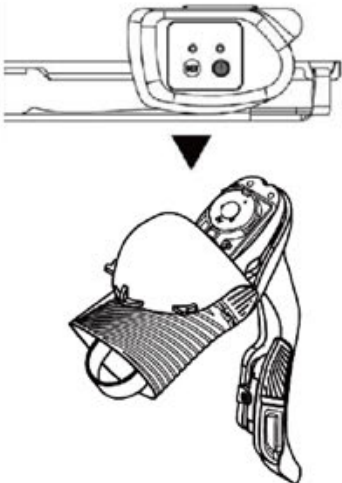

# Connecting Shifters Disc Brake

 <p><b>4</b></p>	<p>The Pairing LED indicator light will turn solid red.</p>	
	<p>After powering on, press and hold the set button until both LEDs flash green.</p>	
 <p><b>6</b></p>	<p>Press and hold the power button until the LED turns solid Blue (about 6s).</p> <p>Once the blue light turns off on the front derailleurs and the pairing light on the shifter flashes and turns off, pairing mode is complete.</p>	

## TIPS

Repeat the above process for the other shifter.



# Drivetrain Parts



# Part Names

FSA K-Force WE is an electronic hybrid drivetrain. It is defined as hybrid because it is not completely wireless. Indeed, there are no wires from shifters to derailleurs but the communication between the two derailleurs is still achieved using wires. The different parts of the drivetrain will be explained in this section.

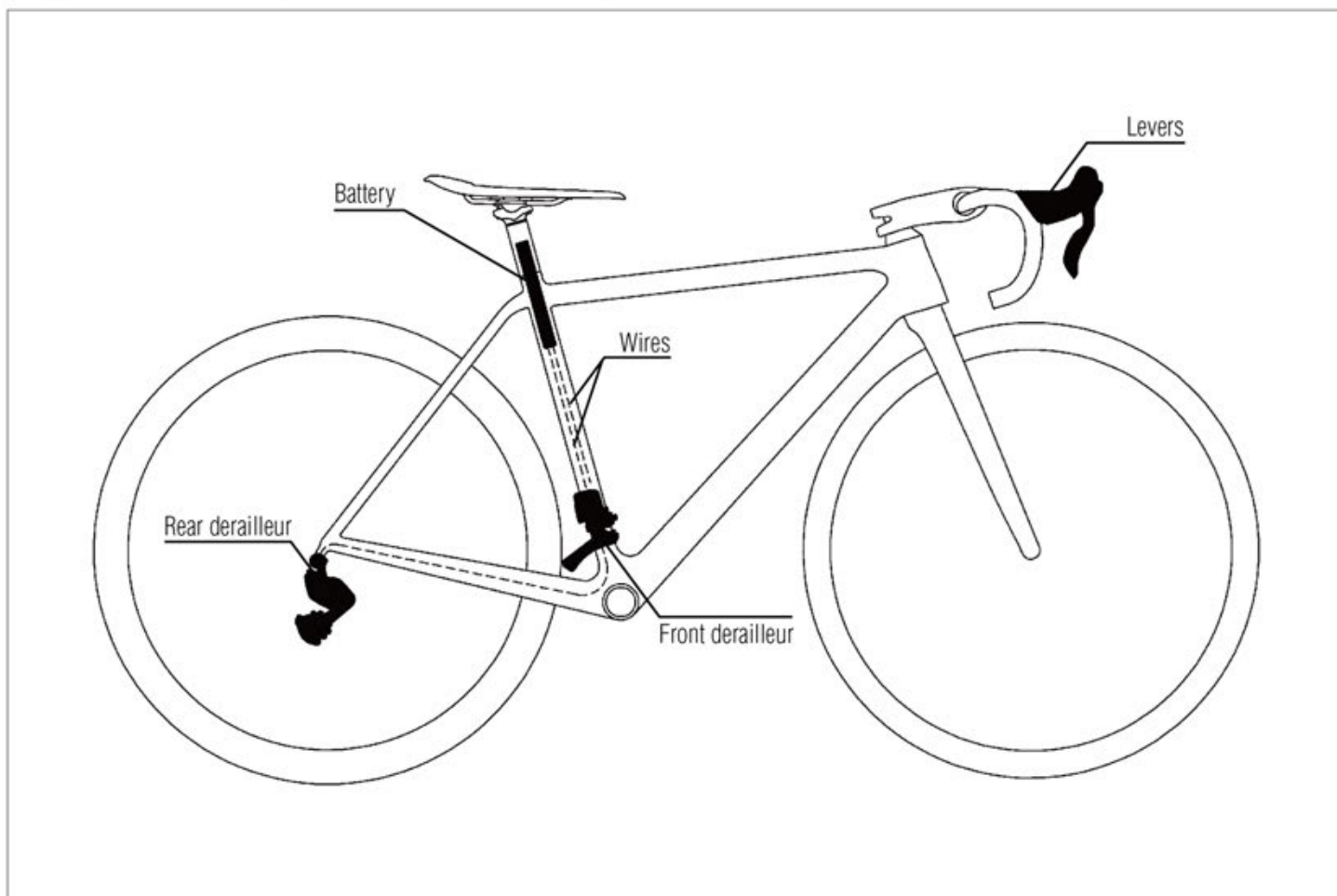

## **Levers:**

Shifters wirelessly communicate with derailleurs. They have their own coin cell batteries (CR2032), located inside the housing.

## **Battery:**

The main battery is placed into the seatpost and provides power to the two derailleurs through two wires.

## **Front derailleur:**

Maximum tooth differential up to 16T, compatible with K-Force WE crankset.



## **Rear derailleur:**

Max sprocket up to 32T, compatible with K-Force WE cassette.

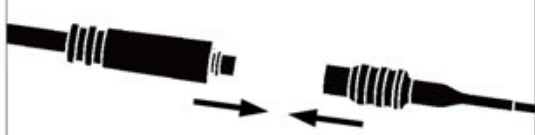

## **Wires:**

Two internally routed wires, one longer and one shorter, connect front and rear derailleurs to the battery.

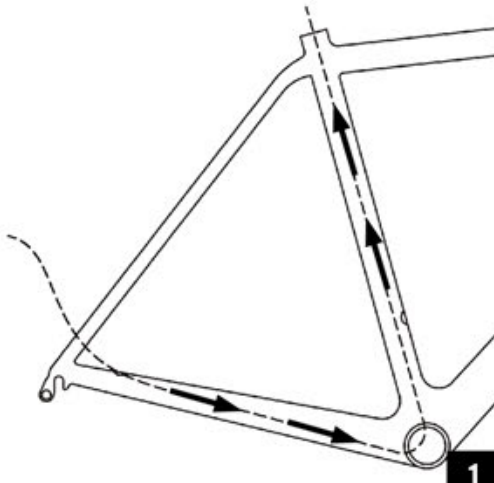

# Using the Wiring tool

 <p>1</p>	<p>Connect the power guide tool to the wires.</p>	<p>FSA Cable tool</p>
 <p>2</p>	<p>After the wires are connected, start routing the cables.</p>	<p>FSA Cable tool</p>

# How to wire

 <p>A line drawing of a bicycle frame showing the rear triangle. A dashed line indicates the path of the rear derailleur wire starting from the chainstay, going up the seat tube, and then down to the rear derailleur. A solid line with arrows shows the wire's path. A small circle at the bottom of the seat tube indicates the entry point. A black box with the number '1' is in the bottom right corner.</p>	<p>Using the FSA wire guide, route the reare derailleur wire starting in the chainstay and then up through the seat tube.</p>	<p>FSA Cable tool</p>
 <p>A line drawing of a bicycle frame showing the rear triangle. A dashed line indicates the path of the front derailleur wire starting from the lower front derailleur port, going up through the top of the seat tube, and then down to the front derailleur. A solid line with arrows shows the wire's path. A small circle at the bottom of the seat tube indicates the entry point. A black box with the number '2' is in the bottom right corner.</p>	<p>Using the FSA wire guide, route the wire from the lower front derailleur port up through the top of the seat tube.</p>	<p>FSA Cable tool</p>

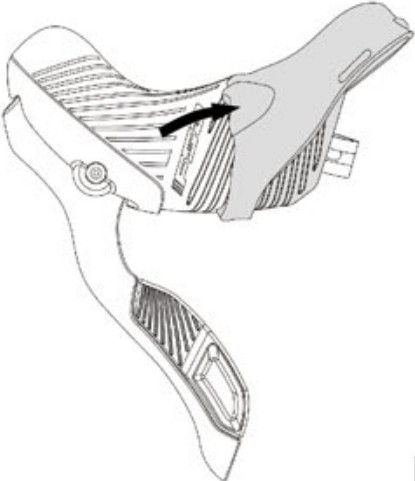
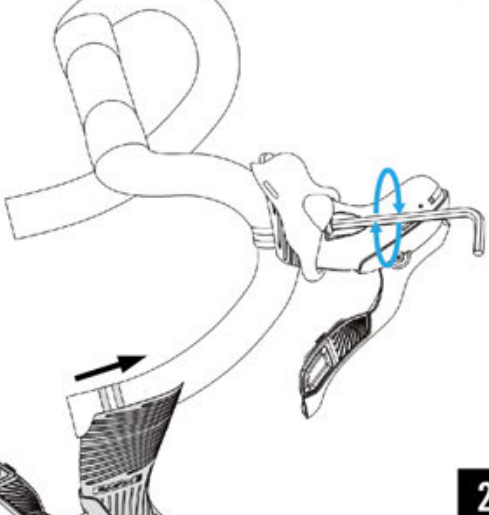

# Lever Installation

 <p>1</p>	<p>Roll the shifter hood forward to expose the shifter clamp bolt. Install the shifter on the handlebar.</p>	
 <p>2</p>	<p>Position the shifter according to preference. Tighten the bolt with a 5 mm hex wrench to 6-8 Nm.</p>	 <p>TORQUE 6-8nm</p>

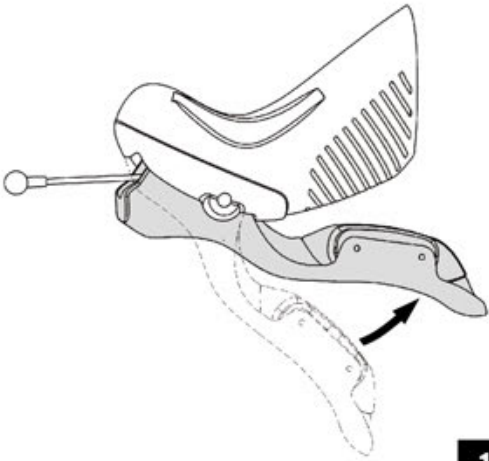
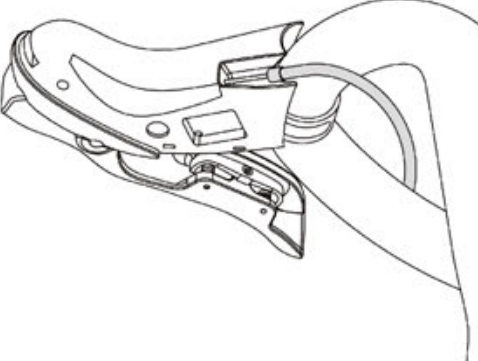

# Brake Cable Installation

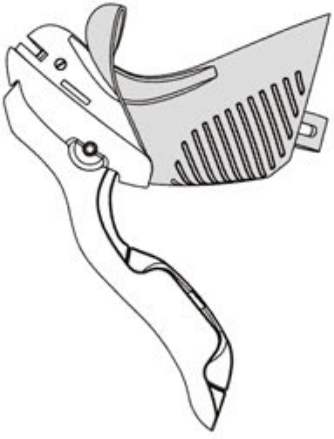
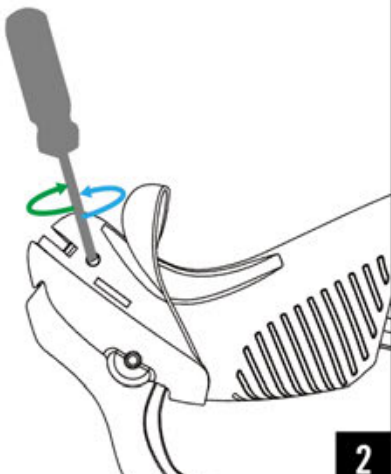
 <p>A line drawing of a motorcycle brake lever assembly. The brake lever is shown in a retracted position, indicated by a curved arrow pointing towards the handlebar. A small hole is visible on the side of the lever housing, which is the cable routing hole. A small black box with the number '1' is located in the bottom right corner of the diagram.</p>	<p>Press the brake lever to expose the cable routing hole.</p>	
 <p>A line drawing showing the brake cable being inserted into the shifter mechanism. The cable is shown entering a hole in the shifter housing and then passing through a hole in the brake cable housing. A small black box with the number '2' is located in the bottom right corner of the diagram.</p>	<p>Brake cable routing into the shifter and brake cable housing.</p>	

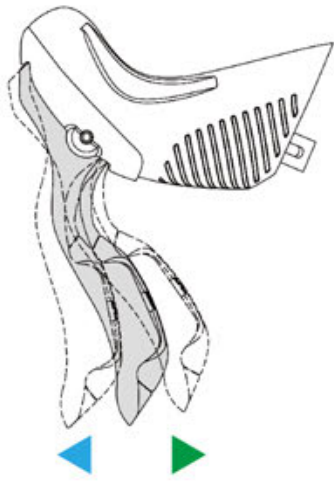
# Reach Adjustments

 <p>1</p>	<p>Expose the reach adjustment screw.</p>	
 <p>2</p>	<p>Adjust reach by tightening or loosening the screw with a 2mm hex wrench.</p>	
 <p>3</p>	<p>Increase the reach by turning the screw counter-clockwise. Decrease the reach by turning the screw clockwise.</p>	

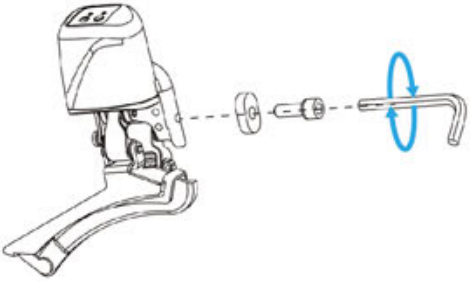
# Front Derailleur Installation

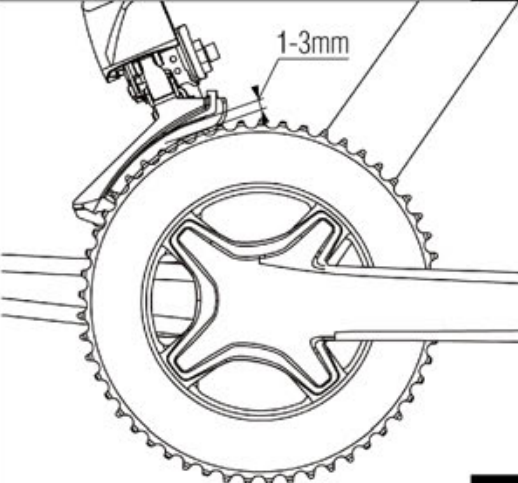
 <p><b>1</b></p>	<p>Mount the front derailleur to the frame as shown.</p>	
 <p><b>2</b></p>	<p>Adjust the gap between the big ring and outer plate of the front derailleur from 1-3mm.</p>	





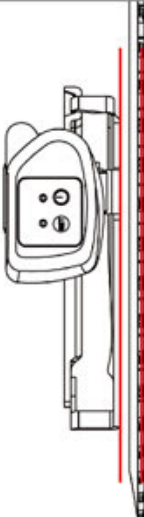
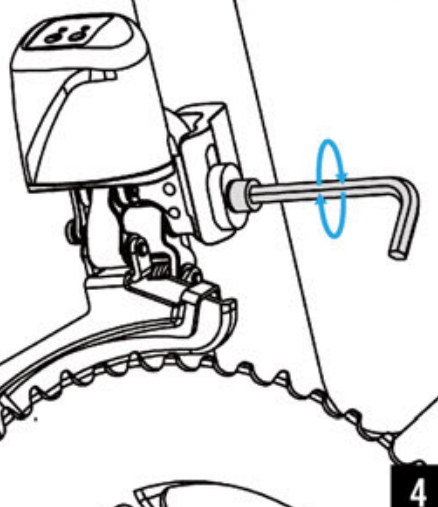
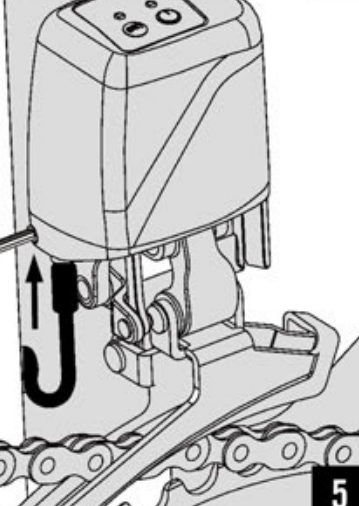

Continued on the next page 

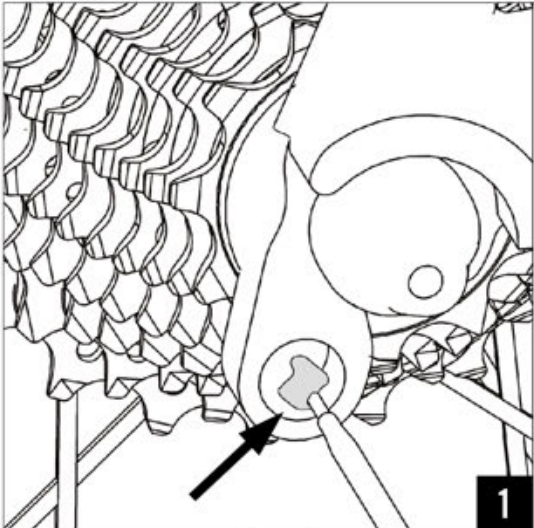

# Front Derailleur Installation

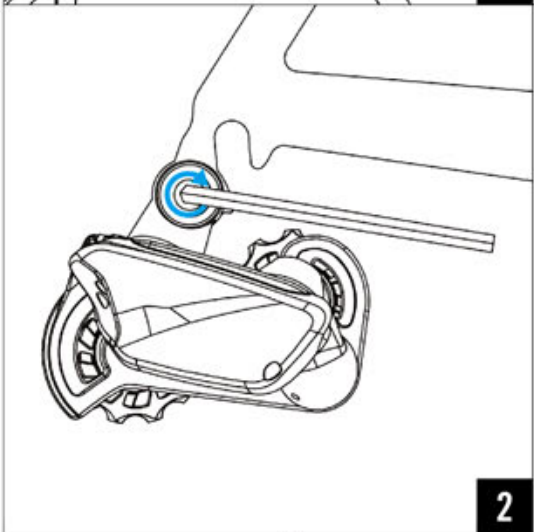
 <p>3</p>	<p>After gap adjustment, make sure the outer plate is parallel with the large chainring.</p>	
 <p>4</p>	<p>After correct placement, tighten the mount bolt to recommended torque of 5-7Nm with a 5mm hex wrench.</p>	<p><b>5</b> mm</p> <p>TORQUE 5-7nm</p>
 <p>5</p>	<p>Install the front derailleur wire in the port on the rear of the front derailleur. Make sure there is a noticeable "click" to confirm proper engagement of the wire.</p> <p>Tighten the pinchbolt for the wire with a 1.5mm hex wrench to 3-5 Nm.</p>	<p><b>1.5</b> mm</p> <p>TORQUE 3-5nm</p>

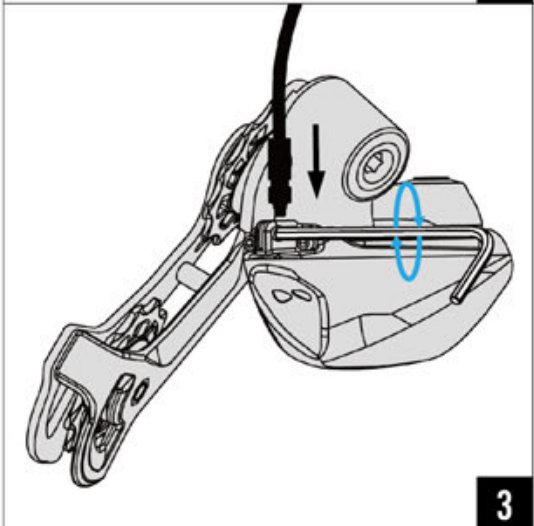

# Rear Derailleur Installation

 <p>Diagram 1 shows a close-up of the rear derailleur hanger threads. A black arrow points to the threads, and a small grey square indicates the application of grease. A black box with the number '1' is in the bottom right corner.</p>	<p>Apply a small amount of grease on the derailleur hanger threads.</p>	
 <p>Diagram 2 shows a 5 mm hex wrench being used to tighten the derailleur bolt. A blue circle highlights the hex wrench's tip. A black box with the number '2' is in the bottom right corner.</p>	<p>Using a 5 mm hex wrench, screw the derailleur in to the hanger. Tighten the derailleur bolt to 5-7 Nm.</p>	 
 <p>Diagram 3 shows the rear derailleur wire being inserted into the port behind the B-knuckle. A black arrow points to the wire, and a blue circle highlights the pinchbolt. A black box with the number '3' is in the bottom right corner.</p>	<p>Install the rear derailleur wire into the port behind the B-knuckle of the rear derailleur. Make sure there is a noticeable "click" to confirm proper engagement of the wire.</p> <p>Tighten the pinchbolt for the wire with a 1.5mm hex wrench to 3-5 Nm.</p>	 

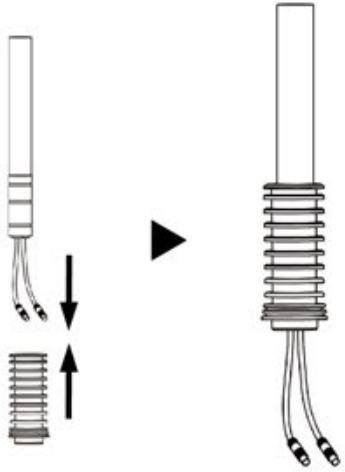
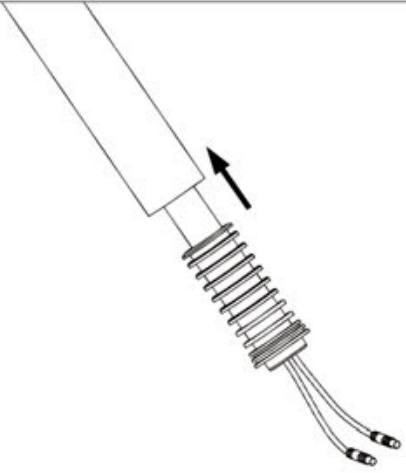
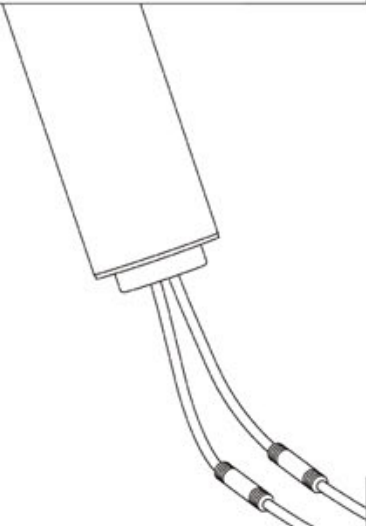
# Battery Installation

	<p>Insert battery in the battery adaptor.</p>	
	<p>Fully insert the battery and adaptor in the seatpost and check that it is secure.</p>	
	<p>Plug the derailleur wires in to the battery terminal leads. Either lead can work for either wire.</p>	

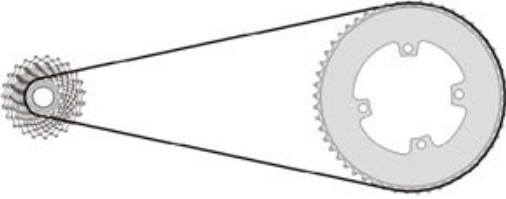
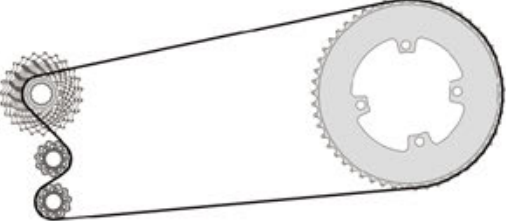
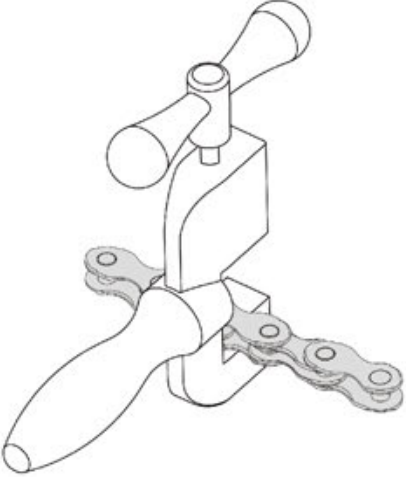
# Chain Installation

 <p><b>1</b></p>	<p>Install the chain around the big chainring and smallest cog. Route it through rear derailleur cage.</p>	
 <p><b>2</b></p>	<p>In this position, bring the two ends of the chain together until the derailleur cage is vertical. This is the correct chain length.</p>	
 <p><b>3</b></p>	<p>Use a chain tool to cut the chain to the correct length</p>	

# Chain Installation

## Chain lock

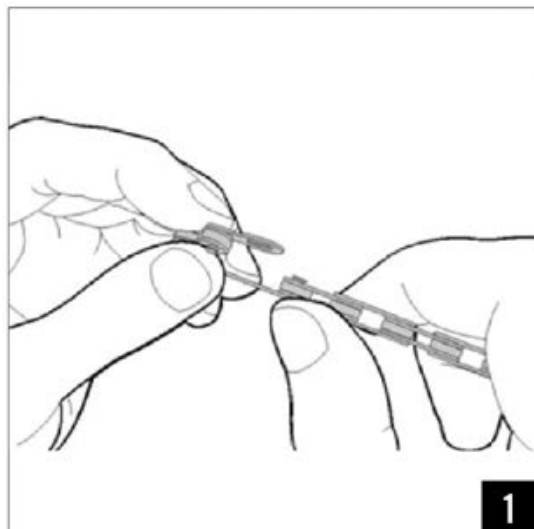

Insert the plates of the Drive Link on opposing sides of each chain end.

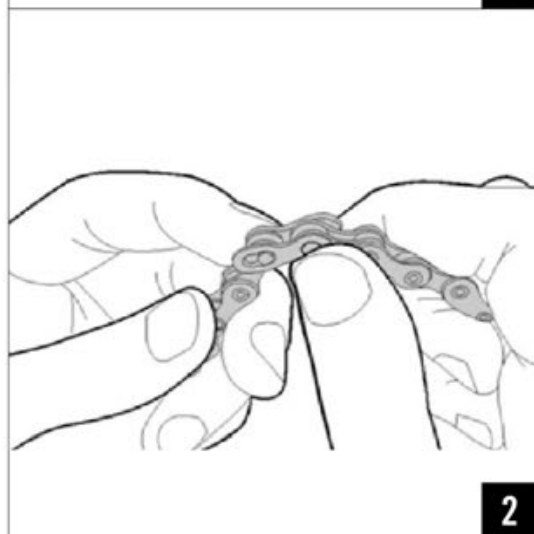

Insert and hook the drive link pins into the opposite plate.

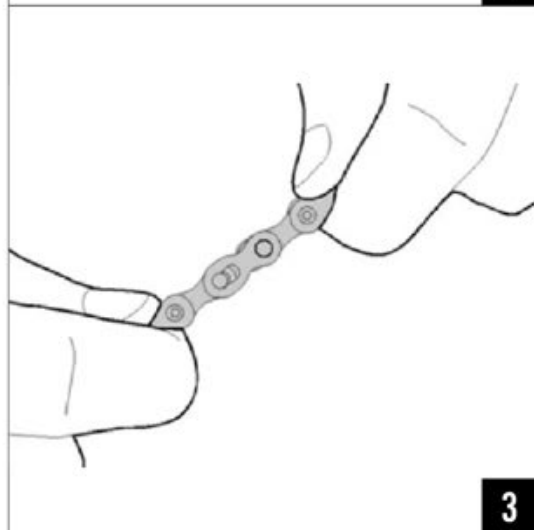

To snap Drive Link in locked position, rotate crank until Drive Link is above the chainstay.  
Hold the rear brake and firmly push the crank forward.

### TIPS

Make sure Drive Link snaps in to locked position before use.

# Chain Installation

## Unlock the chain

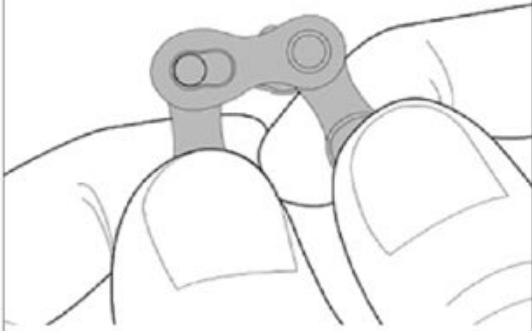
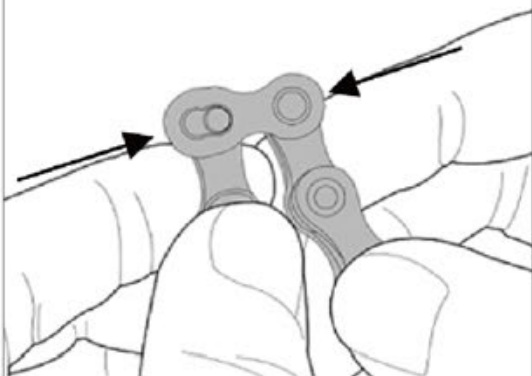
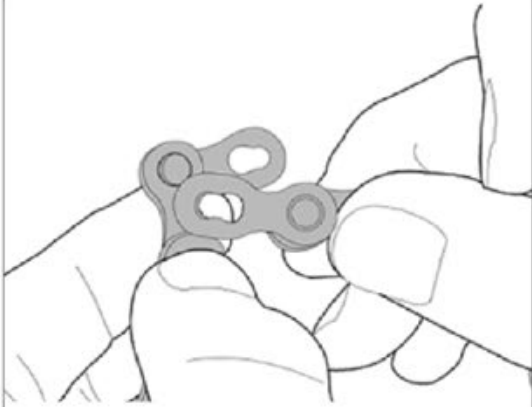
 <p>1</p>	<p>To disconnect the Drive link, isolate the link.</p>	
 <p>2</p>	<p>Firmly squeeze the link bushings together so that the pins and plates decouple.</p>	
 <p>3</p>	<p>Pull the plates apart.</p>	

### TIPS

Drive Link cannot be reused if removed. Use a new Drive Link to reassemble.

**How to operate**

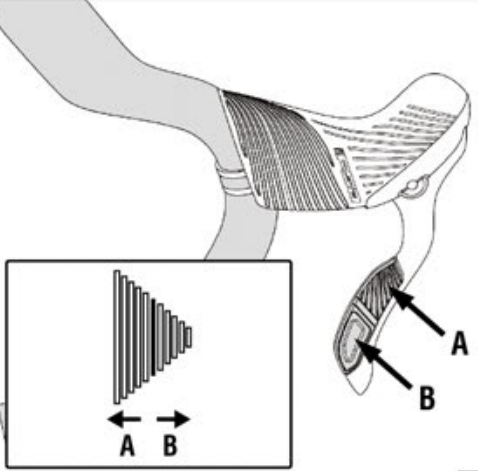
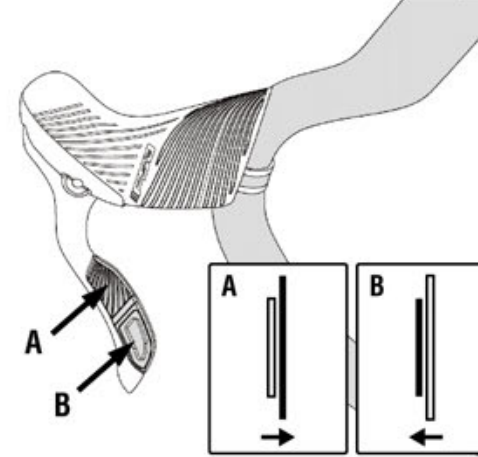

# Gear position control

 <p><b>1</b></p>	<p>The right shifter controls the movement up and down the cassette. Press button A to move toward the big cogs, button B to move toward the small cogs.</p>	
 <p><b>2</b></p>	<p>The left shifter controls the front derailleur on the front chainrings. Button A will shift to the big ring, button B to the small ring.</p>	



## Usage and adjustments

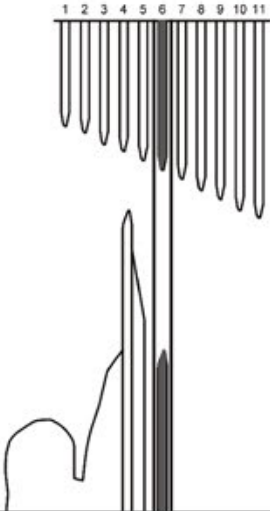
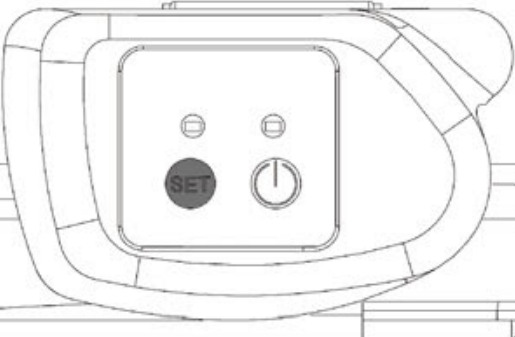
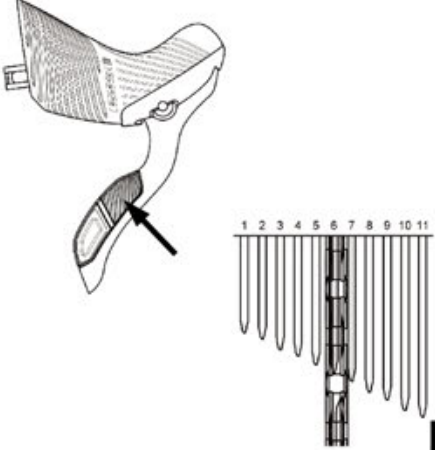

# Rear Derailleur Adjustment

 <p><b>1</b></p>	<p>Shift the chain to the small chairing. Shift the rear derailleur to the center (6th) cog.</p>	
 <p><b>2</b></p>	<p>Enter set mode by pushing and holding the SET button for 2 seconds. Both LEDs will blink green.</p>	
 <p><b>3</b></p>	<p>Rotate the crank and micro-shift the rear derailleur up until the chain begins to rub on the next cog.</p>	

Continued on the next page **///**

# Rear Derailleur Adjustment

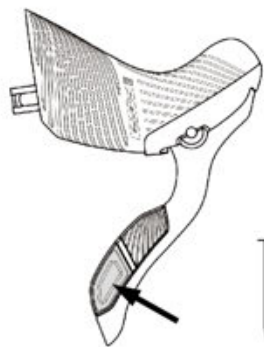

4

Move the RD three micro-steps back and double check the alignment — The upper jockey pulley on the rear derailleur should be in line with the center cog.

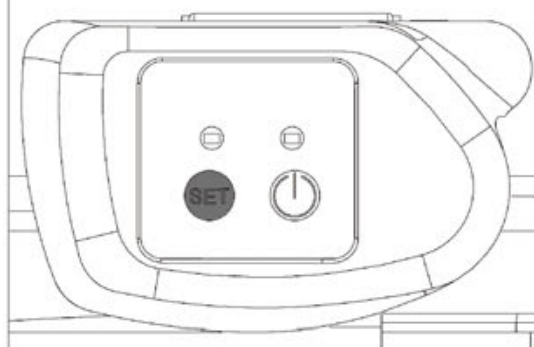

5

Push and hold the SET button for 2 seconds to exit the mode. The green light will stop blinking and the rear derailleur zero position will be saved.

# Front Derailleur Adjustment

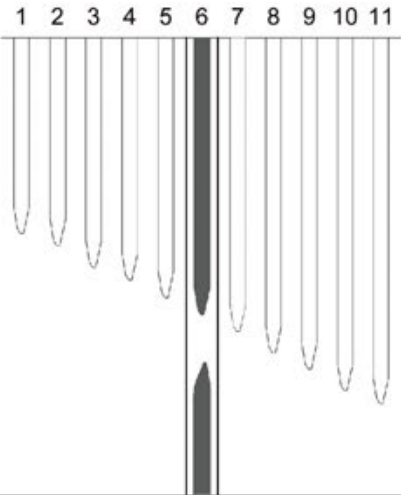
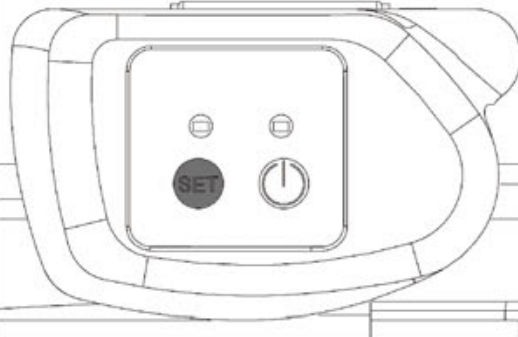
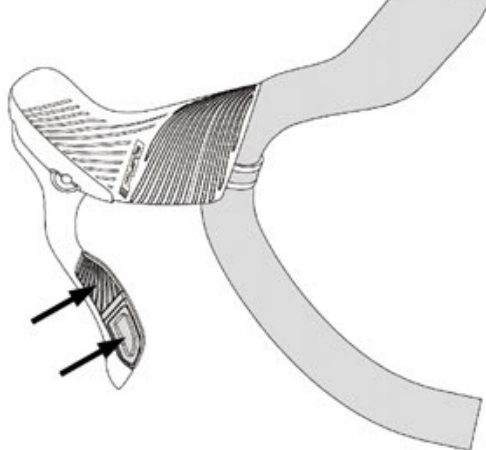

 <p>1</p>	<p>Shift the rear derailleur to the center (6th) cog.</p>
 <p>2</p>	<p>Enter set mode by pushing and holding the SET button for 2 seconds. Both LEDs will blink green.</p>
 <p>3</p>	<p>Press either front shifter button to enter the front derailleur adjustment mode.</p>

## TIPS

1. Enter the front derailleur adjustment mode (By factory default is the left one but you can change it in the WE Dashboard Software).
2. Rotate the crank when pressing the front derailleur button. The front derailleur will shift when the button is pressed, so make sure the chain can change rings if required.

Continued on the next page **///**



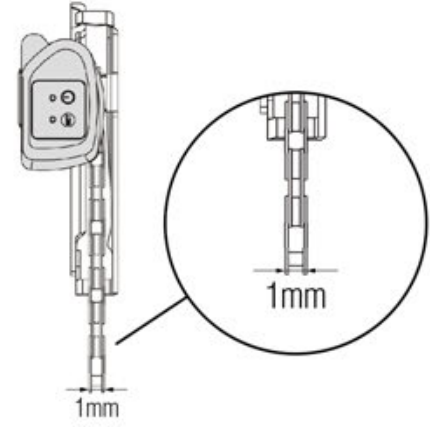

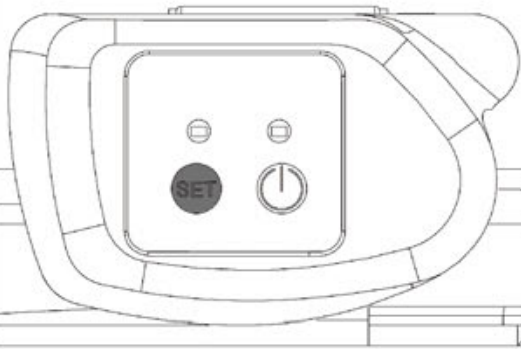

# Front Derailleur Adjustment

 <p>A side-view diagram of a front derailleur. Two horizontal arrows point towards the derailleur cage from the left and right. A vertical arrow points downwards from the top of the cage towards the chainring.</p>	<p>The front derailleur will move in to the gear selected.</p>	
 <p>Two side-view diagrams of a front derailleur. The left diagram shows the cage plate shifted towards the chainring. The right diagram shows the cage plate shifted away from the chainring.</p>	<p>Micro-adjust the front derailleur position using the REAR shifter. Shift between chainrings using the front shifter.</p>	
 <p>A side-view diagram of a front derailleur with a circular callout. The callout shows a close-up of the cage plate and chainring with a horizontal dimension line indicating a 1mm gap between them. A similar 1mm dimension line is shown at the bottom of the main diagram.</p>	<p>Big chainring adjustment: Using the REAR shifter, adjust the derailleur cage plate position. Ensure 1mm of clearance (not more) between the outer derailleur cage plate and the chain.</p>	

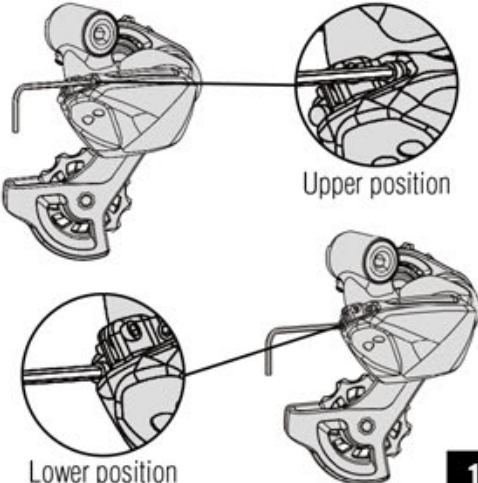
# Front Derailleur Adjustment

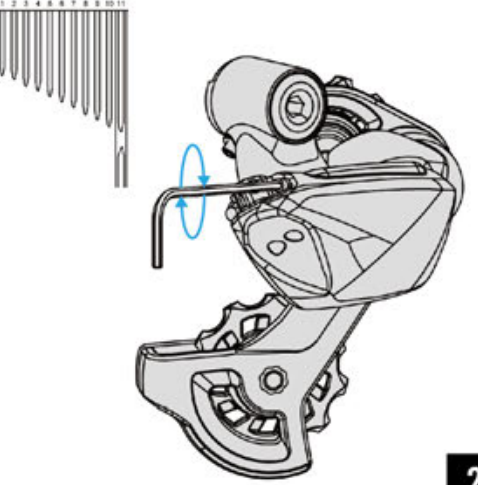
 <p>1mm</p> <p><b>7</b></p>	<p>Small chainring adjustment: Using the REAR shifter, adjust the derailleur cage plate position. Ensure approximately 1mm (not more) of clearance between the inner derailleur cage plate and the chain.</p>	
 <p><b>8</b></p>	<p>When both inner and outer positions are adjusted properly, exit set mode---push and hold the SET button for 2 seconds. The green light will stop blinking and the front derailleur zero position will be saved.</p>	

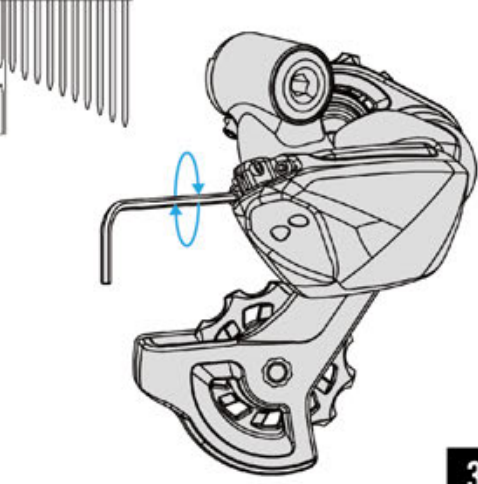
# Limit Screw Adjustment

 <p>Upper position</p> <p>Lower position</p> <p>1</p>	<p>After aligning both derailleurs proceed with the limit screw adjustment. There are two screws on the back, one for lower and one for upper limit adjustment.</p>	
 <p>2</p>	<p>Upper Position Adjustment: To adjust the upper position limit, shift the rear derailleur to the largest cog. Then tighten the upper position screw (outermost screw) until it touches the internal stop. Back the limit screw off a half-turn.</p>	
 <p>3</p>	<p>Lower Position Adjustment: To adjust the lower position limit, shift the rear derailleur to the smallest cog. Then tighten the lower position screw (innermost screw) until it touches the internal stop. Back the limit screw off a half-turn.</p>	

## TIPS

Do not tighten the limit screw against its stop. Tightening may result in reduced performance or damage to RD internals.

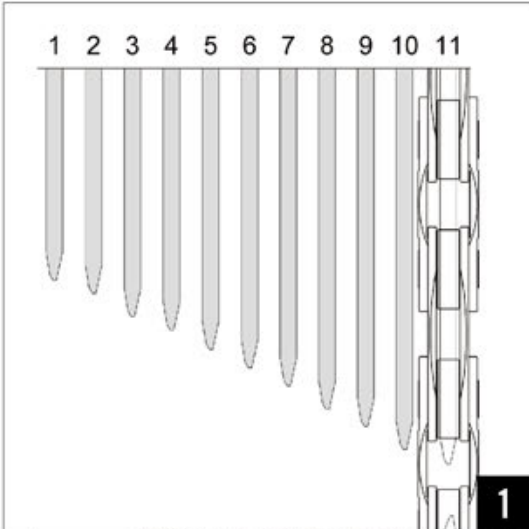
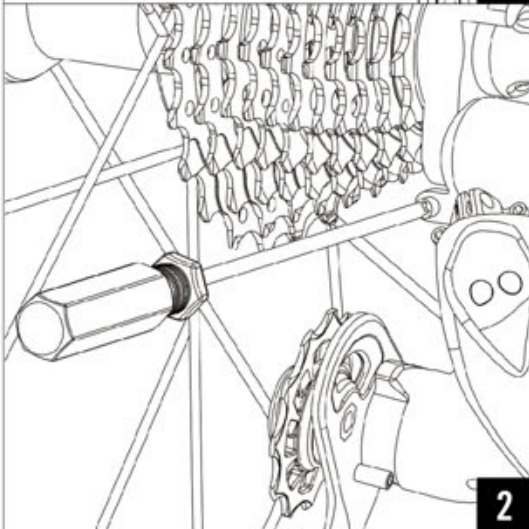

# B-tension Screw Adjustment

	<p>Shift the rear derailleur to the largest cog.</p>	
	<p>Adjustments: Turn the screw clockwise: To increase space between the pulley and the cog. Turn the screw counterclockwise: To decrease the space between pulley and the cog.</p>	

## TIPS

1. B-tension screw adjustment must be set after all derailleur and limit screw adjustments. B-tension screw adjustment optimizes the distance between the upper jockey pulley and cassette cogs.
2. For optimal shifting, move the pulley as near as possible to the cog without making contact.
3. When B-tension is set, double check RD functionality and adjustment. If RD need adjustment, repeat the adjustment process.



**Battery**



# Names of parts

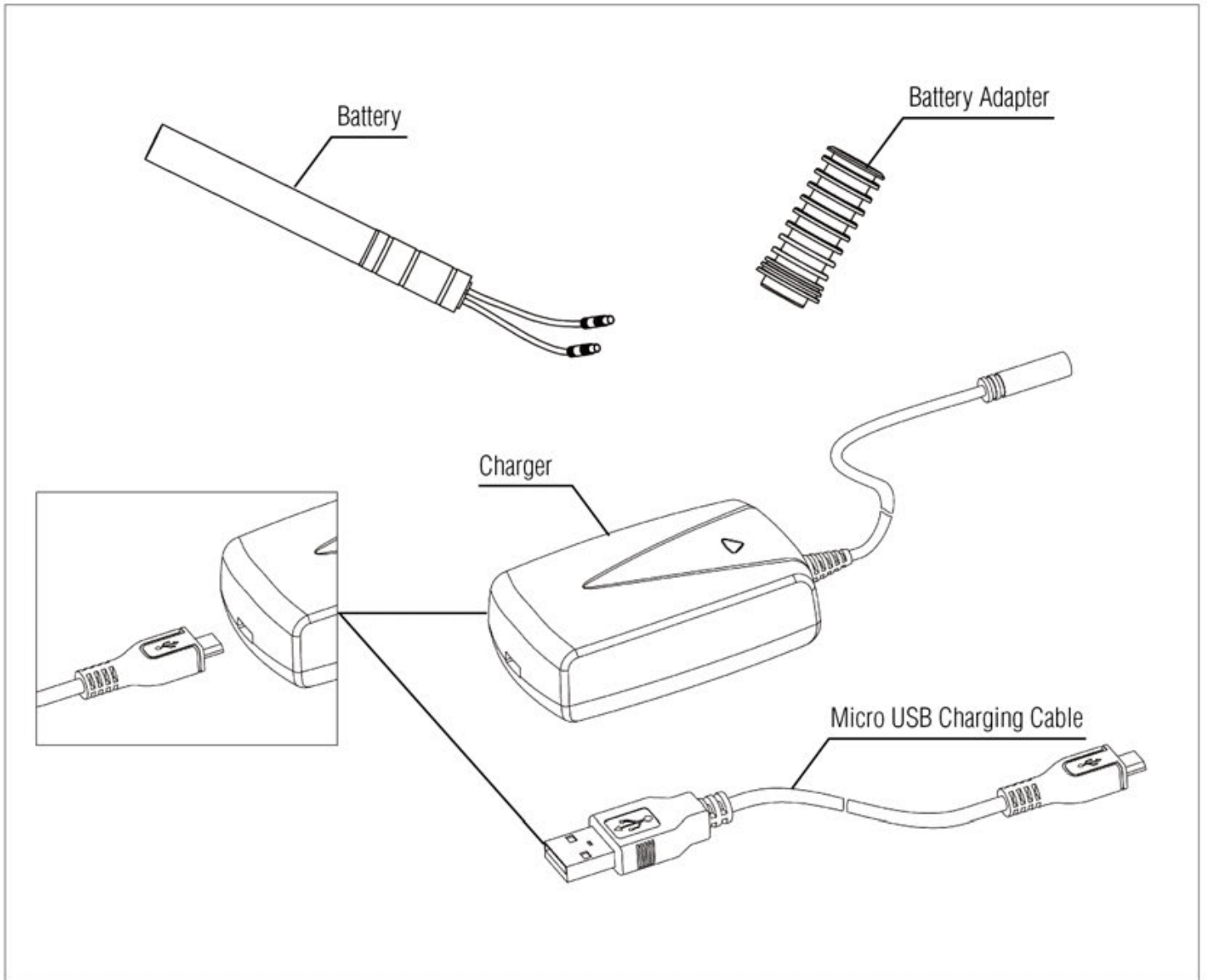

# Battery Diagnostic

<p>Main Battery</p> <p>Shifter battery</p> <p style="text-align: right;"><b>1</b></p>	<p>WE uses three batteries. The main battery powers the front and rear derailleurs. Each shifter is powered by a CR2032 coin cell battery.</p>
<p>LED 1</p> <p style="text-align: right;"><b>2</b></p>	<p><b>Main battery</b> When WE is on, the LED 1 on the main control unit will blink every 3 seconds (customizable by We Dashboard App). Main battery level is indicated by the following LED color codes.</p>
<p>LED 1</p> <p>LED 2</p> <p style="text-align: right;"><b>3</b></p>	<p><b>Shifter battery</b> The shift batteries are CR2032 coin cell batteries and are not rechargeable. When the battery level is low, they must be replaced. It is not necessary to replace both batteries at the same time if they are not both showing a low charge.</p> <p>Each time a shift button is pressed a corresponding LED will blink on the main controller. LED 1 blinks for the right shifter, LED 2 blinks for the left shifter. The color of the LED will be related to the level of the battery.</p>

## TIPS

LED Color	Battery Level	Action
	77-100%	Battery level is high, no action necessary.
	23-77%	Battery level is OK.
	0-23%	Replace battery as soon as possible.
	0%	Replace battery immediately. The Shifter will stop to work.

# How to Charge

## Shifter battery replacement

 <p>A line drawing of a shifter battery cover. An arrow points upwards from the bottom edge, indicating the direction to fold the cover forward.</p>	<p>Fold the back of brake hood forward and the battery cover will be exposed.</p>	
 <p>A line drawing of the shifter battery cover with a Philips screwdriver inserted into a slot. A blue circular arrow indicates the direction of rotation.</p>	<p>Use Philips screwdriver to loose the battery cover.</p>	
 <p>A line drawing of the shifter battery cover with a flat blade screwdriver inserted under the edge. A circular inset shows a close-up of the screwdriver blade wedged under the cover, with two upward-pointing arrows indicating the direction of leverage.</p>	<p>Use flat blade screwdriver to leverage and remove the battery cover.</p>	



### TIPS

Battery LED signal please check 7-2.

Continued on the next page 

# How to Charge

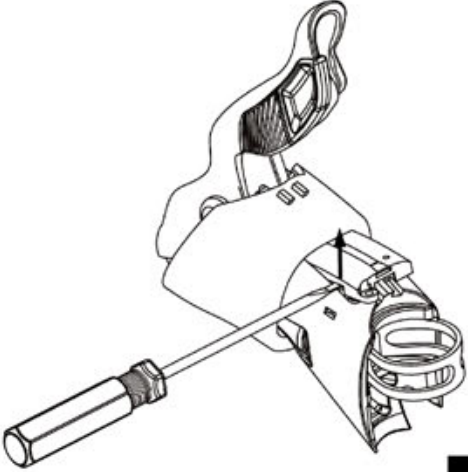
## Shifter battery replacement

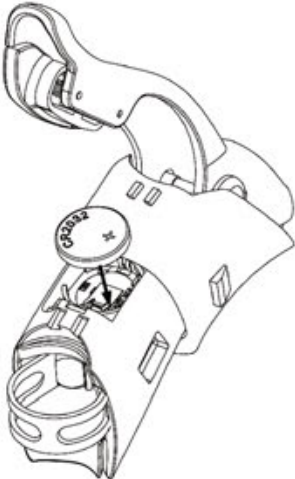



 <p data-bbox="555 678 604 725"><b>4</b></p>	<p data-bbox="635 230 1337 338">Once the battery cap is partially open, use the flatblade screwdriver to get under the cap and fully remove the cap from the shifter.</p>	
 <p data-bbox="555 1205 604 1252"><b>5</b></p>	<p data-bbox="635 757 994 790">Remove the battery and replace.</p>	

### TIPS

Battery LED signal please check 7-2.

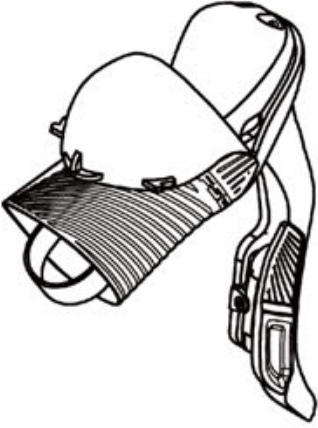
# How to Charge

## Shifter battery replacement - Disc Brake



 <p>1</p>	<p>Roll the shifter hood backward to expose the transmitter cover.</p>	
 <p>2</p>	<p>Use the 1.5mm hex key to remove the transmitter cover.</p>	
 <p>3</p>	<p>Remove the battery and replace.</p>	

### TIPS

Battery LED signal please check 7-2.

# How to Charge

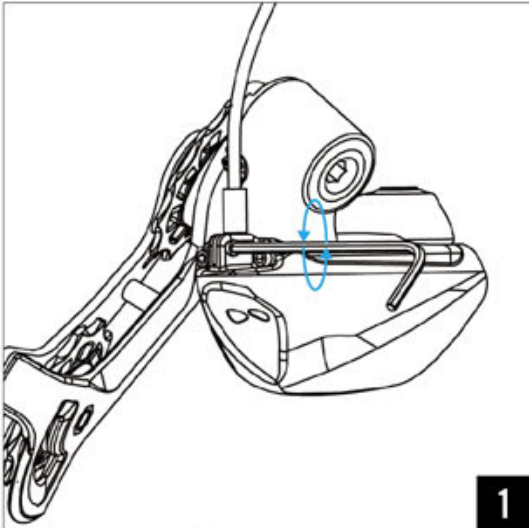
## Main battery charging

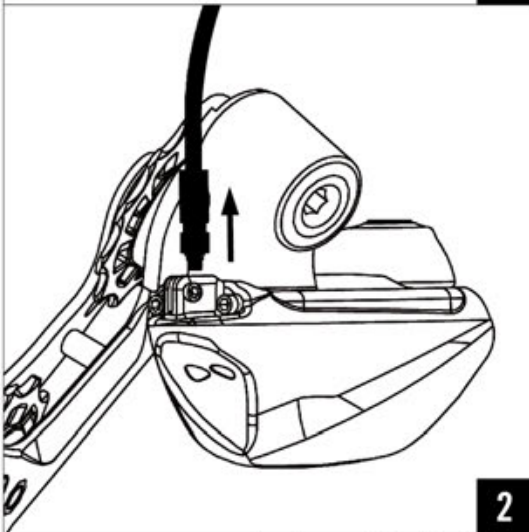
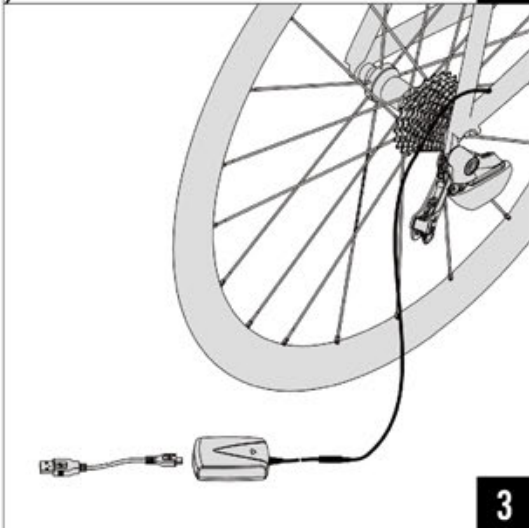
	<p>Use 1.5mm hex wrench to unscrew the rear derailleur wire clamp.</p>	
	<p>Unplug the wire from the rear derailleur.</p> <p>Note: Grab the plastic end of the wire. Do NOT pull on the rubber coated wire only.</p>	
	<p>Plug the wire in to the WE charger, then plug the charger in to outlet.</p>	

### TIPS

1. Turn WE off before charging the battery.
2. Battery LED signal please check 7-2.

Continued on the next page 



# How to Charge

## Main battery charging

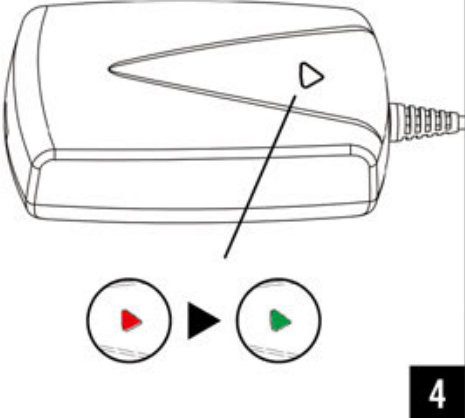
 <p data-bbox="550 672 598 725">4</p>	<p data-bbox="635 224 1324 302">The charger light will be red while charging and turn to green at full charge.</p>	
--	--	--

### TIPS





1. Turn WE off before charging the battery.
2. Battery LED signal please check 7-2.



# Disc Brake Installation

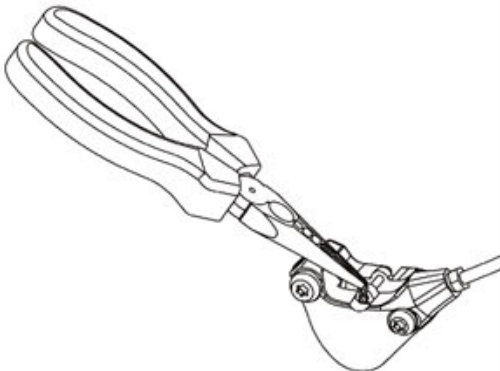

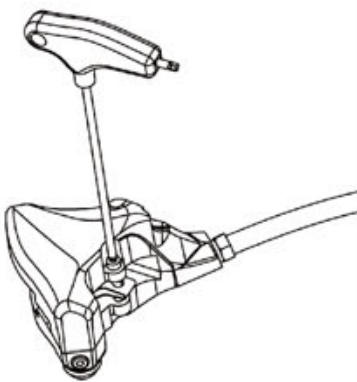

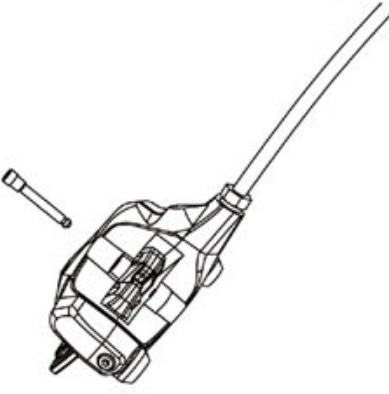

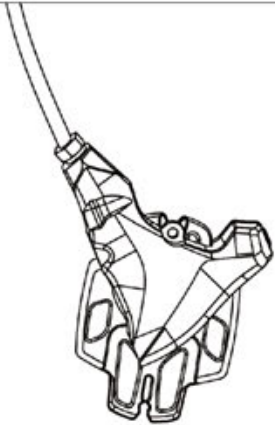

# Disc Brake Installation

 <p><b>1</b></p>	<p>Remove brake system from packaging. Locate caliper pad pin and retention clip. Remove retention clip.</p>	
 <p><b>2</b></p>	<p>Using T10 wrench, remove pad retention pin.</p>	
 <p><b>3</b></p>		

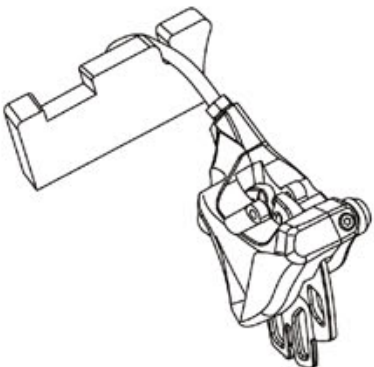
Continued on the next page 

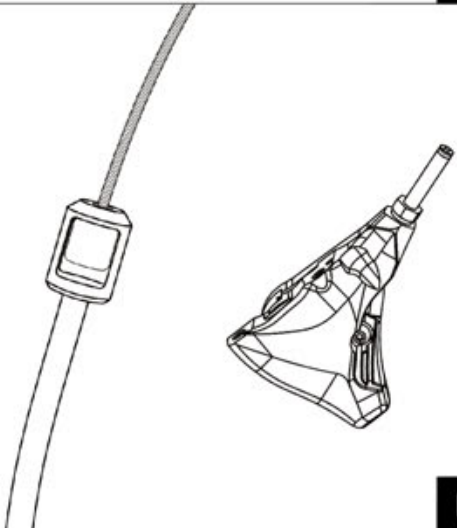
# Disc Brake Installation

 <p><b>4</b></p>	<p>Install provided FSA bleed block between caliper pistons.</p>	
 <p><b>5</b></p>	<p>Cut brake hose at caliper end. Leaving 25mm or 1" of exposed hose from the top of the compression nut.</p>	
 <p><b>6</b></p>	<p>Install provided hose caps (2) on lever side of hose ends.</p>	

Continued on the next page 

# Disc Brake Installation

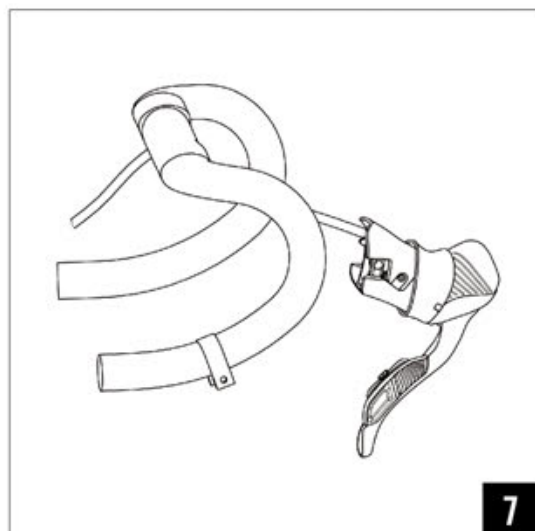

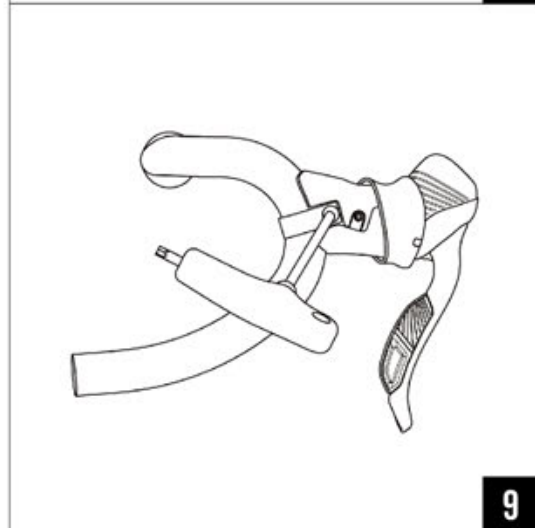
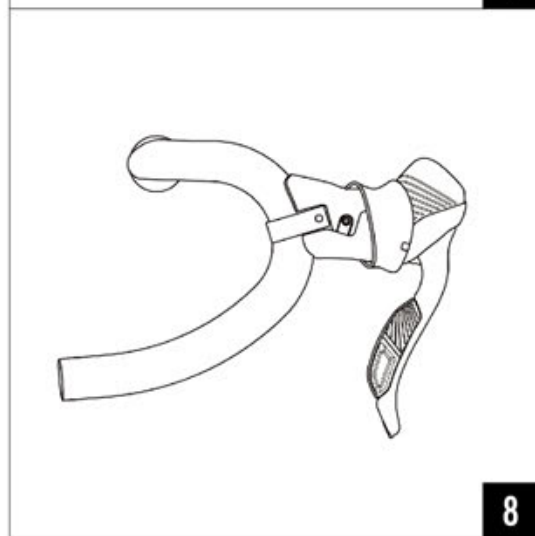

Mount lever and clamp to handlebar using T25 wrench to 6Nm.





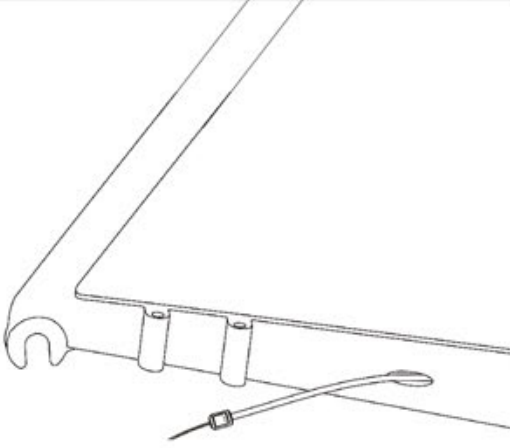

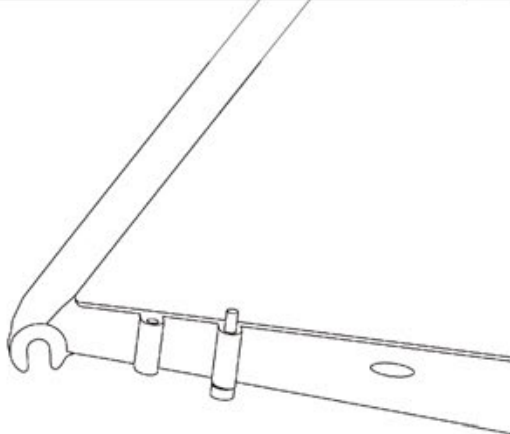
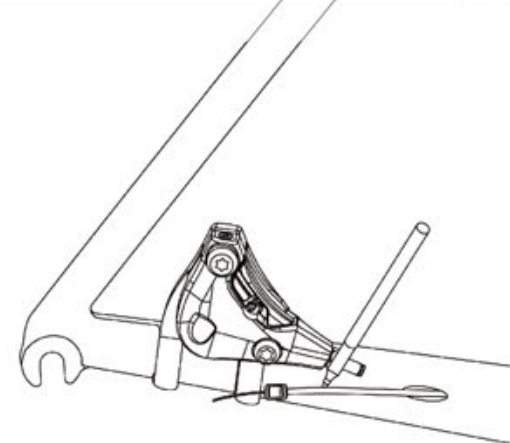
Continued on the next page **///**

# Disc Brake Installation

 <p>10</p>	<p>Route brake hose to caliper location.</p> <p>Note: this may include internal handlebar and frame routing.</p>	
 <p>11</p>	<p>Mount caliper to disc brake frame or fork location.</p> <p>Note: caliper mount bolts should protrude through mount 7-9mm.</p>	
 <p>12</p>	<p>Make a line at the end of the caliper.</p>	

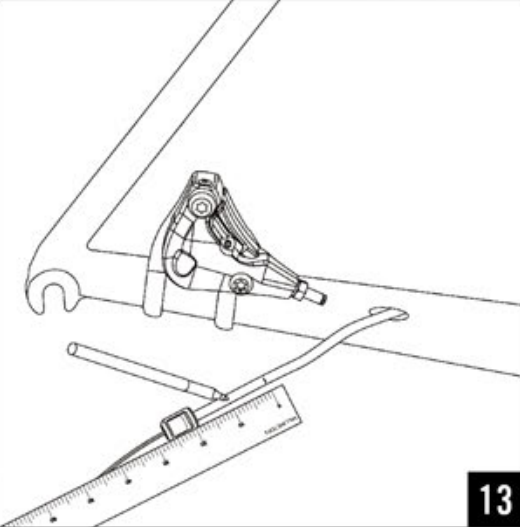
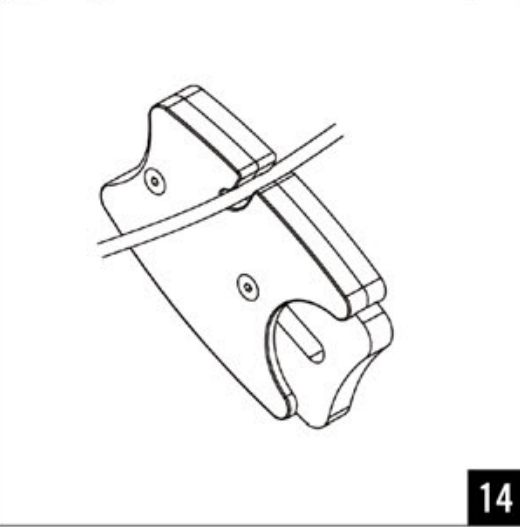
Continued on the next page //

# Disc Brake Installation

 <p><b>13</b></p>	<p>Measure 10mm down the line towards end of hose and make a second mark.</p>	
 <p><b>14</b></p>	<p>Using hose cutting tool make a cut at the second mark.</p>	
 <p><b>15</b></p>	<p>Remove caliper from the frame or fork . With the caliper hose point up use an 8mm wrench to remove compression nut and hose.</p> <p>Note: careful to not spill brake fluid.</p>	

Continued on the next page 

# Disc Brake Installation



16

Remove hose cap and compression nut from hose.  
Store caliper in vertical position.

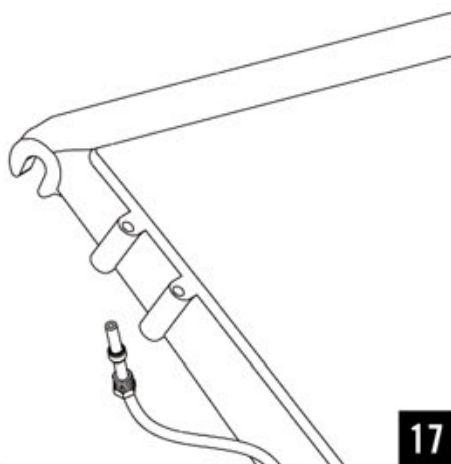

17



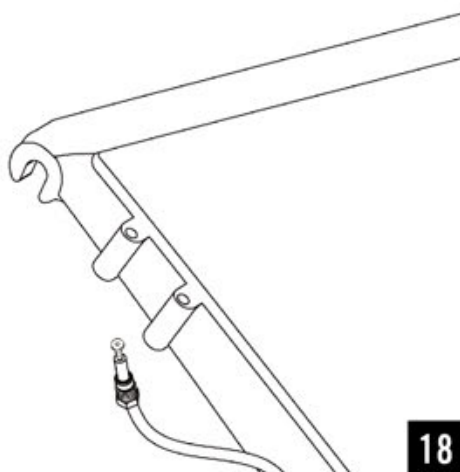

Install compression nut and bushing on to hose.

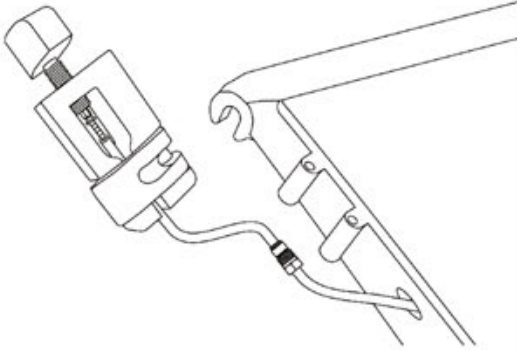

18

Continued on the next page **///**

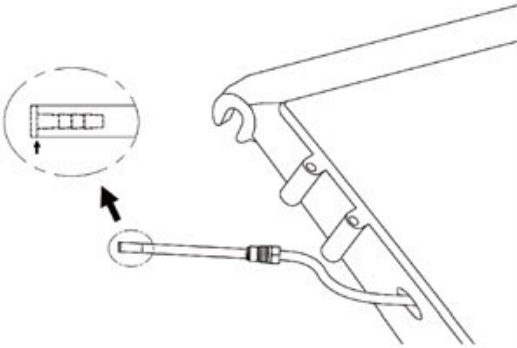

# Disc Brake Installation

 <p><b>19</b></p>	<p>Install hose barb into hose end using barb insert tool.</p>	
 <p><b>20</b></p>	<p>Confirm hose barb end is flush with hose end.</p>	
 <p><b>21</b></p>	<p>Assemble and setup bleed kit syringes using provided instructions.</p>	

Continued on the next page //



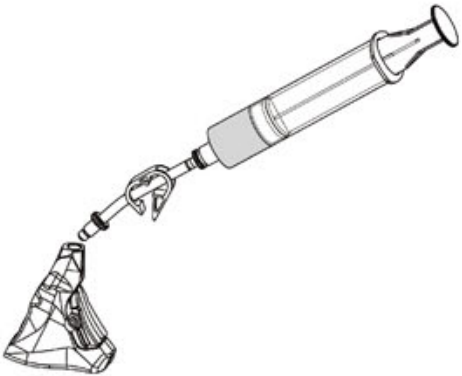

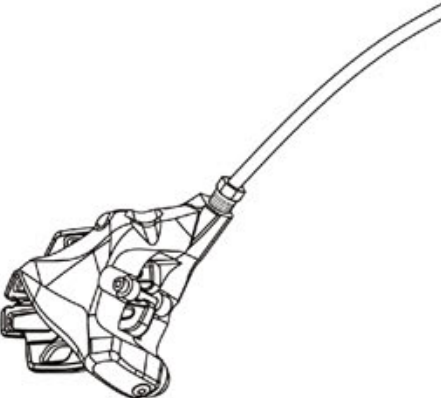

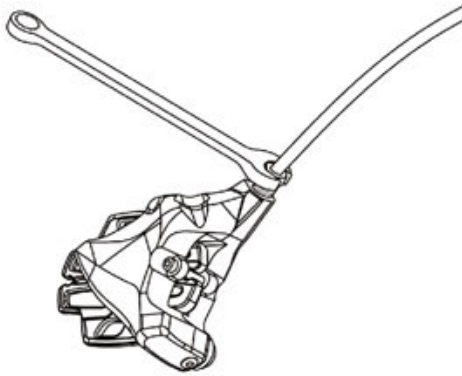

# Disc Brake Installation

 <p><b>22</b></p>	<p>Add a few drops of FSA mineral oil into the caliper hose connection. Confirm fluid level is up to bottom of thread.</p>	
 <p><b>23</b></p>	<p>Insert hose with barb, compression bushing, and nut. Confirm hose is fully seated in the caliper.</p>	
 <p><b>24</b></p>		

Continued on the next page **///**

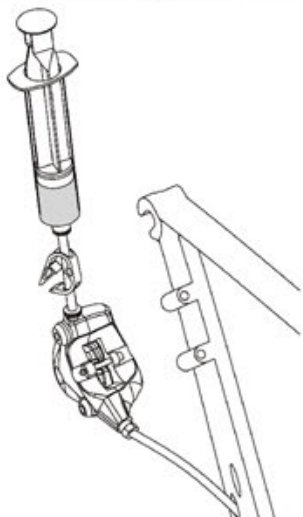
# Disc Brake Installation

 <p><b>25</b></p>	<p>While holding hose in place; Tighten compression nut with 8mm wrench to 9N.m.</p>	 <p>8mm</p>
 <p><b>26</b></p>	<p>Confirm caliper bleed plug is vertical, Using T10 wrench remove bleed plug from caliper and install syringe. Firmly tighten syringe fitting.</p>	 <p>T10</p>
 <p><b>27</b></p>	<p>Position the caliper and syringe so they are above hose connection with the bleed port at the highest point.</p> <p>Finish with light push on plunger and close red clip on syringe hose. Keeping bleed port vertical and at highest position remove syringe. Confirm fluid is visible in bleed port.</p> <p>Lightly pull on syringe plunger to remove air from connection. Push fluid into caliper with plunger. Note: Repeat this process until you no longer remove air.</p>	

Continued on the next page ///

# Disc Brake Installation

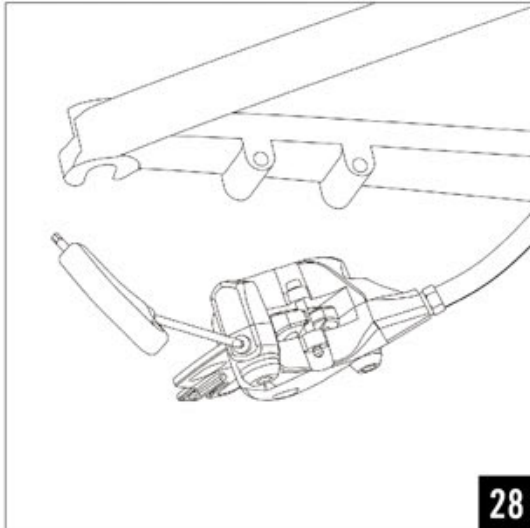

Install bleed plug and o-ring. Tighten to 2N.m.

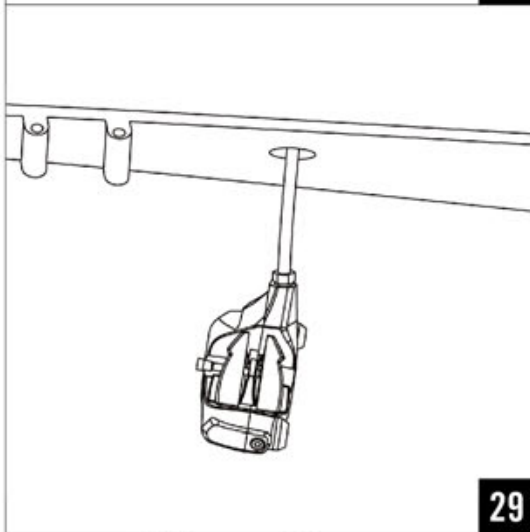

Squeeze lever blade several times ensuring that has firm feel and does not have excess travel.  
Clean caliper with isopropyl alcohol and rag.  
Install brake pads and pad spring using T10 wrench.





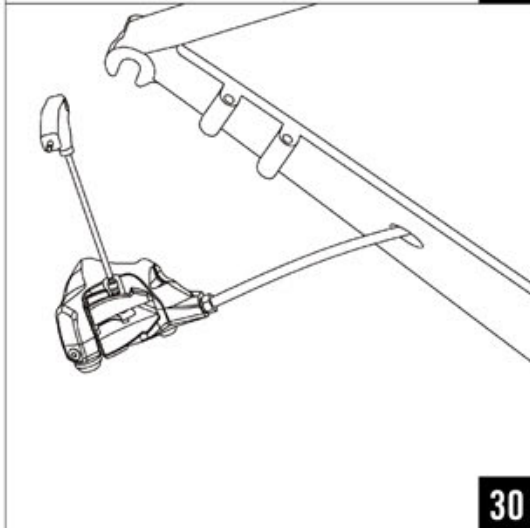

Note: brakes are left and right specific.

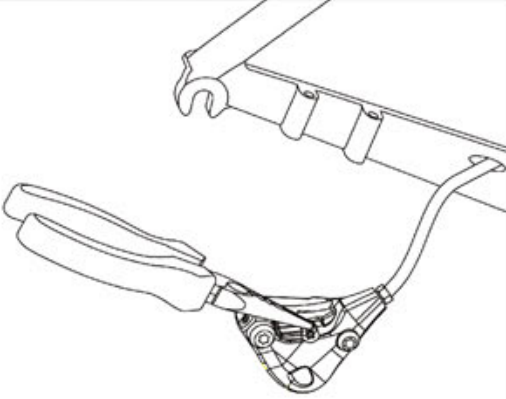

Continued on the next page **///**

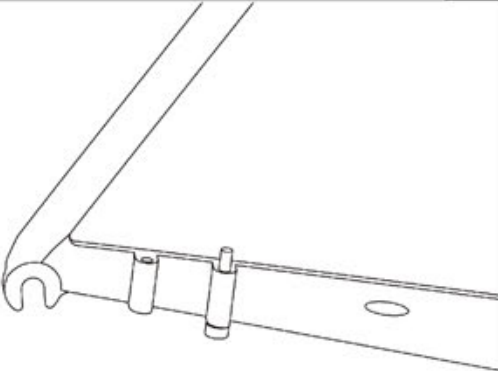
# Disc Brake Installation







 <p><b>31</b></p>	<p>Install pad pin retention clip.</p>	
 <p><b>32</b></p>	<p>Mount caliper to disc brake frame or fork location Note: caliper mount bolts should protrude through mount 7-9mm Do not fully tighten caliper mount bolts at this time.</p>	
 <p><b>33</b></p>	<p>Install wheel and rotor into frame or fork. until space between pads and rotor is even on either side. Tighter caliper mount bolts to 6N.m.</p>	

## TIPS

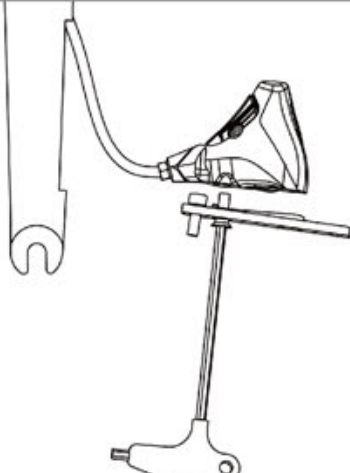

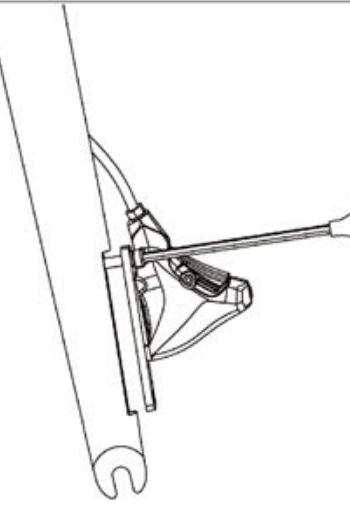
Repeat steps 1-32 for both calipers.

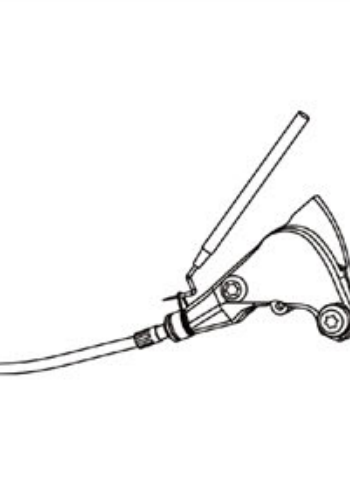
Continued on the next page 

# Disc Brake Installation

 <p>34</p>	<p>Install caliper on to mount bracket using caliper mount bracket bolts. Tight to 6Nm. Note: caliper can only be installed in one direction. Note: when using 160mm front mount bracket install upper mount bolt below installing caliper.</p>	
 <p>35</p>	<p>Install caliper mount bracket and caliper using universal mount bolts (size). Squeeze lever and tighten mount bolts. Slowly rotate wheel and confirm brake pads are not rubbing on the rotor. If pads are rubbing on rotor. Stop wheel from rotating and make small adjustment to the caliper. Tighten bracket mount bolts to 6N.m.</p>	
 <p>36</p>	<p>Quick connect fitting: Garter spring Use a small pick to lightly pull up on the Gater spring.</p>	

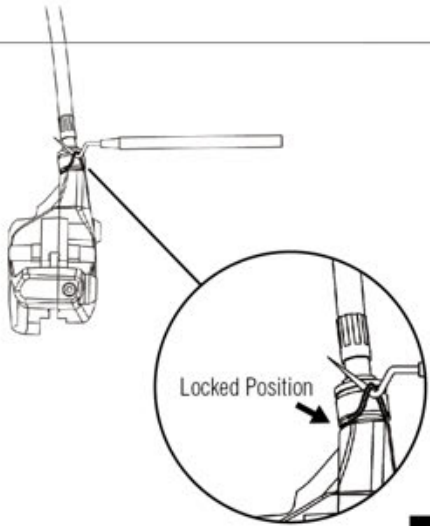

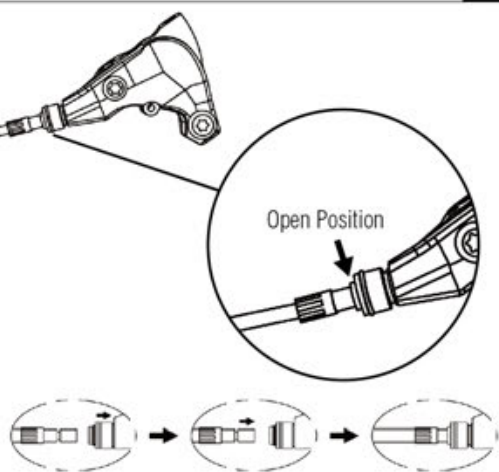
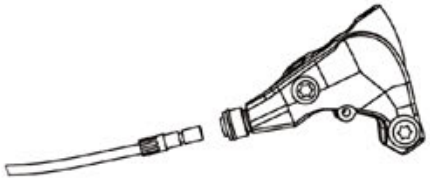
# Disc Brake Installation

 <p>37</p>	<p>Move Garter spring from locked position to open position.</p>	
 <p>38</p>	<p>Move Garter spring to locked position after re-installing the hose end.</p>	
 <p>39</p>	<p>Remove hose end from Quick connect fitting.</p> <p>Install wheel and rotor into frame or fork. until space between pads and rotor is even on either side. Tighter caliper mount bolts to 6Nm.</p>	

Continued on the next page 

# Disc Brake Installation

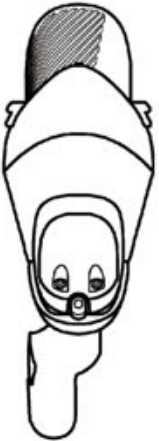
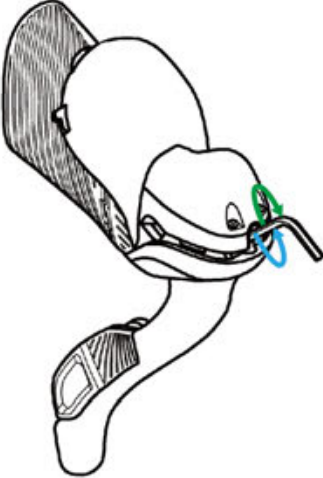
## Reach Adjustment - Disc Brake

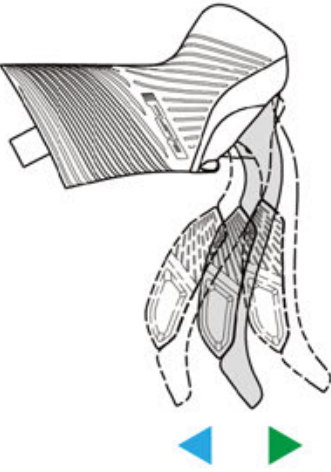

 <p><b>1</b></p>	<p>Expose the reach adjustment screw by pulling back the hood.</p>	
 <p><b>2</b></p>	<p>Adjust reach by loosening or tightening the screw with a 2.5mm hex wrench.</p>	
 <p><b>3</b></p>	<p>Increase the reach by turning the screw counter-clockwise. Decrease the reach by turning the screw clockwise.</p>	

**Diagnostic**



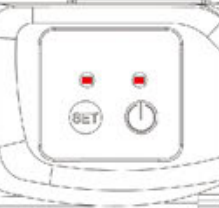
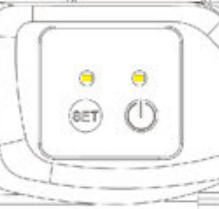
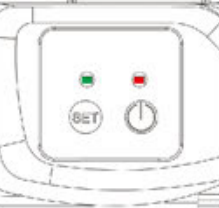

# Diagnostic

Action	LED Indication	Issue	Remedy
	Both LEDs solid red	Front derailleur stall	<ul style="list-style-type: none"> <li>• Check that the derailleur is mounted correctly</li> <li>• Check the SET point</li> </ul>
	Both LEDs solid yellow	Rear derailleur stall	<ul style="list-style-type: none"> <li>• Check that the derailleur is mounted correctly</li> <li>• Check the SET point</li> </ul>
	LED 1 solid green and LED2 solid red	Communication absence between front and rear derailleur	<ul style="list-style-type: none"> <li>• Check connections of both derailleurs.</li> <li>• Check wires for damage</li> </ul>
	LED 1 solid red and LED 2 solid green	Failed reply from rear derailleur to front derailleur at end of shift. Probable loss of rear derailleur position	<ul style="list-style-type: none"> <li>• Check the connection of both derailleurs connector.</li> <li>• Check the SET point</li> </ul>